

The Large Size

100x300cm - 120x360cm - 160x320cm



 **Kale**

Kalesinterflex



Index

İçindekiler

- 1.Kalesinterflex**
- 08 **1.1 Kalesinterflex | Redefines Spaces**
Mekanları Baştan Yaratan Buluş, Kalesinterflex
- 10 **1.2 Care For Your World**
İyi Bak Dünyana
- 12 **1.3 Sustainability**
Sürdürülebilirlik
- 14 **1.4 History of Kale**
Kale'nin Tarihçesi
- 16 **1.5 Human Factor**
İnsan Faktörü
- 18 **1.6 KALESINTERFLEX SUPERIOR TECHNOLOGIES**
Kalesinterflex Üstün Yüzey Teknolojileri
- 2. Spaces**
Alanlar
- 26 **2.1 Bathroom**
Banyo
- 30 **2.2 Kitchen**
Mutfak
- 32 **2.3 Interior**
İç Mekan
- 36 **2.4 Exterior**
Dış Mekan
- 3. Collections**
Koleksiyonlar
- 40 **3.1 Marble Look**
Mermer Görünüm
- 66 **3.2 Stone Look**
Doğaltaş Görünüm
- 86 **3.3 Cement Look**
Çimento Görünüm
- 98 **3.4 Metal Look**
Metal Görünüm
- 106 **3.5 Artwall**
Artwall
- 116 **3.6 Solid Colors**
Düz Renkler
- 128 **3.7 Wood Look**
Ahşap Görünüm
- 4. Technical Specifications**
- 137 **4.1 Sizes & Thicknesses**
Kalınlıklar & Ebatlar
- 138 **4.2 Features**
Özellikler
- 140 **4.3 Kaleguard**
- 142 **4.4 Kaleguard Defence**
- 144 **4.5 Services**
Hizmetler
- 146 **4.6 Size Table**
Ebat Tablosu
- 154 **4.7 Technical Specifications**
Teknik Özellikler
- 160 **4.8 Packaging and Shipping Details**
Paketleme ve Gönderim Detayları

**The first and only
largest porcelain
slabs produced
in Turkey:
Kalesinterflex**

*Türkiye'de üretilen
ilk ve tek en büyük
porselen plaka:
Kalesinterflex*

The Large Size
**160x
320**
cm

6mm / 12mm / 20mm



There is a place where imaginations
run with a boundless energy.

Art and science together as one.

Where impossible is an illusion.
A figment. A fiction.

We know this place because we live
and breathe ceramics of
incomparable beauty and quality.

Here we see homes as they
were meant to be.

No dream too great.
No vision too stunning.

It's what's possible when everything
you do rests on deeply held principles.

Technology that inspires with its fusion
of innovation, form, function and performance
in ways that are deeply enduring.

Design that is deeply authentic, breathing
life into every dream, every vision and that brings
new meaning to the spaces in which we live.

A resolve to make sustainability a way of life
as much as it is a way of doing business.
Caring for the future by caring for the world.

It's what happens when you reimagine
what the ultimate covering material could be.

It's what happens when you reimagine possible.

■ Kalesinterflex

*Hayat, hayal edince güzel.
Yaşam alanlarınıza nasıl yeni anlamlar kazandırabiliriz?*

Dünyayı düşünerek başlayalım mı mesela?

*Sürdürülebilir bir ürün düşünün...
Evinizin her yerinde.
İlham veren.*

Ama aynı zamanda ekonomik çözümler de üreten.

*Sadece çevre dostu değil, sizin de dostunuz.
İşlevsellik ve estetik arasında benzersiz bir denge sunan
bir ürün.*

*Hiç aklınıza gelmeyecek bambaşka yerlerde karşınıza
çıktığını düşünün.
Her seferinde şaşırtıyor.
Heyecanlandırıyor.*

*Yenilikçi teknolojisiyle, hayata, dünyaya ve insana değer
katıyor.*

*Şimdi gözlerinizi kapatın.
Dünyayı değiştiren bu yenilikle hayalinizdeki mekanı
tasarladığınızı düşünün.
Rafine bir zevkle.
İncelikle. Zarafetle.*

Ve gözlerinizi dünyaya yeniden açın.

*Hayal ettiğiniz ne varsa,
hayat bulmuş bir şekilde karşınızda.*

*Biz Kalesinterflex'i üretirken hep daha güzelini hayal ettik.
Çünkü hayat, hayal edince güzel.*

■ Kalesinterflex



Kalesinterflex. Redefines Spaces

Life has value in places.

That's why every place has a memory.
Kalesinterflex is designed to give spaces soul
and accompany our lives.

Each experience and emotion, deserve an
exquisite and subtle companionship.
To create new memories by adapting
to modern aesthetics in micro world
that we designed.

There is a revolutionary brand that brings
innovation, aesthetics, and performance
together in the background of our lives.

■ Kalesinterflex

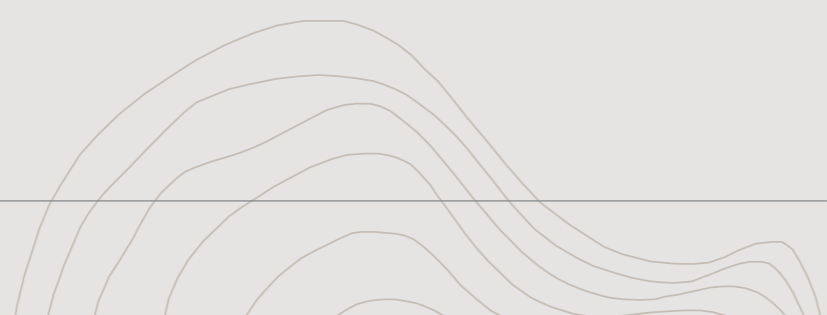

Kalesinterflex. Mekanları baştan yaratan buluş.

Hayatı, mekânlar anlamlandırır.

*Bu yüzden her mekanın bir hafızası var.
Meknlara ruhunu veren Kalesinterflex ise
hayatlarımıza eşlik etmek için.*

*Her deneyim, her duygu; zarif ve incelikli bir
yoldaşlığı hak eder.*

*Tasarladığımız mikro dünyalardaki modern
estetik anlayışına uyum sağlayarak yeni anılar
yaratmak için...*

*Hayatımızın fonunda inovasyonu, estetiği,
performansı bir araya getiren
devrimsel bir marka var.*

■ Kalesinterflex



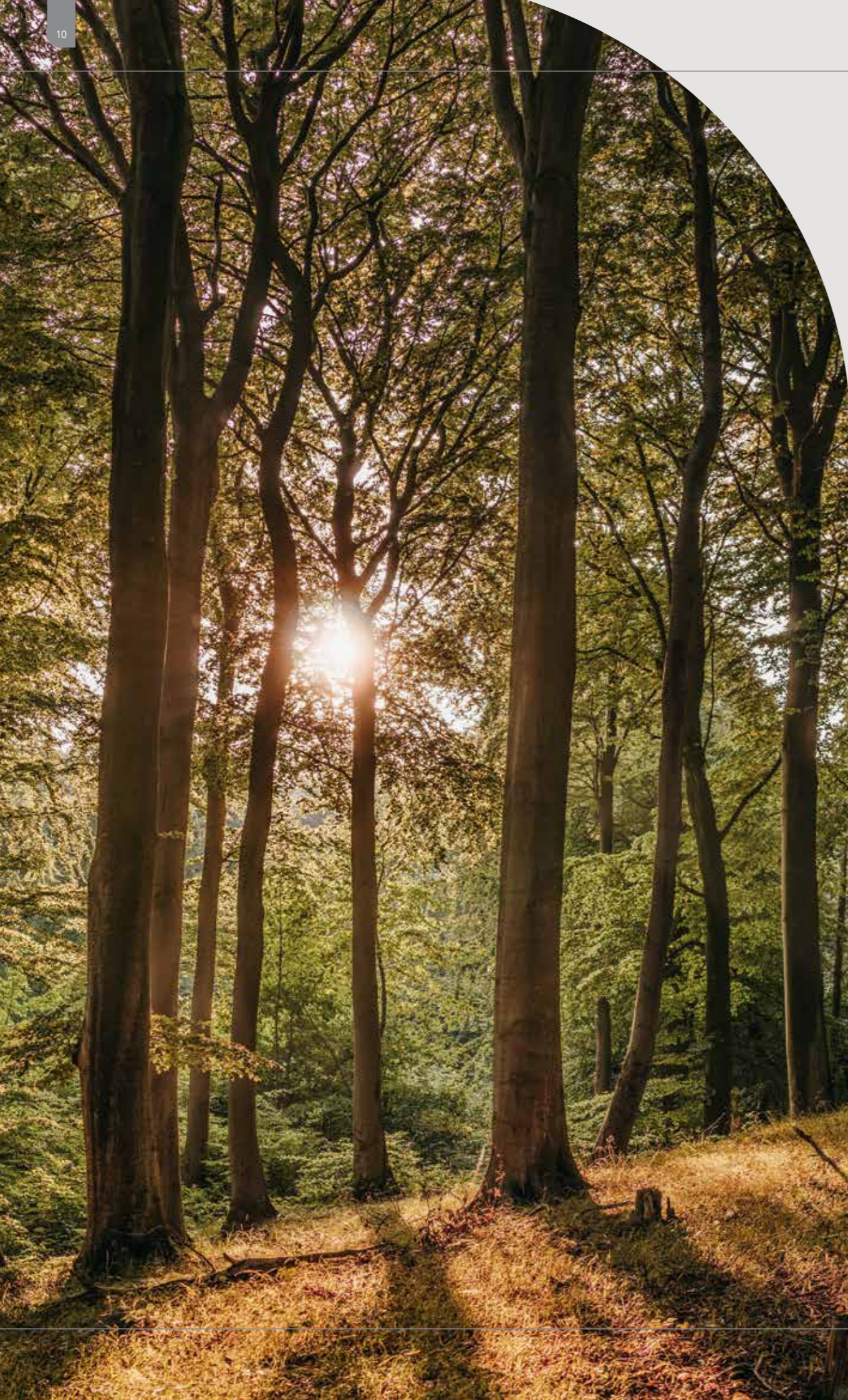

If you can say "what a relief!" as you step in your home...
 If you can see more than four-walls while "inside" ...
 If you can reflect your own colors, own delights as you wish...
 If you can host your dreams as much as your friends for dinner...
 If you can raise a flower, a child, or a hope within the peace of your home...
 Then, your home becomes your world,
 and the world is your home!

And us,

With our design-oriented durable products, with our not only inspirational but also sustainable and economical solutions, with our unique balance between the functionality and esthetics, we are ready to reflect your imagination and style to every corner of your home; to take good care of your home, your world, and you.

"Kale #CareForYourWorld

*Eve adınızı attığınız anda "dünya varmış" diyebiliyorsanız eğer...
 Dört duvardan fazlasını görüyorsanız "içeride" ...
 Kendi renklerinizi, kendi zevklerinizi yansıtabiliyorsanız gönlünüzce...
 Dostlarınız kadar düşlerinizi ağırlayabiliyorsanız sofralarınızda...
 Bir çiçeği, bir çocuğu ya da belki bir ümidi yeşertebiliyorsanız evinizin huzurunda...
 İşte o zaman, eviniz sizin dünyanız,
 dünya sizin eviniz!
 Ve biz,*

*Tasarımı odağa alan dayanıklı ürünlerimiz, ilham verici olduğu kadar sürdürülebilir ve tasarruflu çözümlerimiz, fonksiyonellik ve estetik arasında kurduğumuz eşsiz denge ile hayallerinizi ve tarzınızı yuvanızın her köşesine yansıtılabilmek;
 evinize, dünyanıza ve size iyi bakmak için hazırız.*

"Kale #İyiBak Dünyana

Sustainability

Sürdürülebilirlik

Nature. The place where it all begins. Self-existent, life-giving, color-producing, uniquely shaping.

The inventor of imagination, the owner of creativity, our ultimate inspirer.

We strive We are working to be a consistent part of this part of this miracle that can exist without human beings.

We aim to protect its delicate balance, respect its resources, and adapt to its ecosystem.

It is in our nature to be inspired by nature.

Raw Material Consumption: Compared to standard ceramic tiles,

*Ham madde Tüketimi:
Standart seramik karolarla
karşılaştırıldığında,*

57% less
daha az

Water Consumption: Compared to standard ceramic tiles,

*Su Tüketimi:
Standart seramik karolarla
karşılaştırıldığında,*

20% less
daha az

*Doğa. Her şeyin başladığı yer.
Kendi kendini var etme gücüne sahip, hayat
veren, renklendiren, şekillendiren...*

*Hayalgücünün mucidi, yaratıcılığın sahibi, ilham
vericimiz.*

*İnsandan bağımsız var olabilen bu mucizenin,
dengeli bir parçası olabilmek için çalışıyoruz.*

*Hedefimiz hassas dengesini korumak,
kaynaklarına saygı duymak ve ekosistemine
uyumlanmank.*

Doğadan ilham alarak üretmek doğamızda var.

Natural Gas Consumption: Compared to standard ceramic tiles,

*Doğal Gaz Tüketimi:
Standart seramik karolarla
karşılaştırıldığında,*

47% less
daha az

Logistics: Compared to standard ceramic tiles,

*Lojistik
Standart seramik karolarla
karşılaştırıldığında bir konternerde,*

90% more
daha fazla

products can be transported in a container.
ürün taşınabilirliği sağlıyoruz.



History

Tarihçe

The Kale Group, whose foundations were set by Dr. (h.c.) İbrahim Bodur's Çanakkale Seramik Fabrikaları A.Ş. in 1957, began its industrial journey with the production of ceramics and then expanded into the construction chemicals, logistics, and aviation industries. Today, over 5,000 employees, the Kale Group is spread throughout Türkiye, with Çanakkale as its primary location. Kaleseramik, which pioneered the establishment of the ceramic industry in Türkiye, is a value produced in these lands. Our philosophy is to invest where we earn.

Çanakkale Seramik Fabrikaları A.Ş., Türkiye's first ceramic tile manufacturer, was founded in 1957, and Kalebodur Seramik Sanayi A.Ş., Türkiye's first floor-tile manufacturer, was founded in 1972.

While Çanakkale Seramik set the standards for quality in wall tiles, Kalebodur started a new era in the sector as a generic brand. Çanakkale Seramik Fabrikaları A.Ş. and Kalebodur Seramik Sanayi A.Ş. merged under a single roof in 2000, under the name "Kaleseramik Çanakkale Kalebodur Seramik Sanayi A.Ş.". Kaleseramik, which continues its production under the Çanakkale Seramik and Kalebodur brands, is the world's largest ceramic company, with its production capacity in a single area.

Kalesinterflex porcelain slab was developed in 2005 with the expertise of Kaleseramik, which is the first largest ceramic producer in Türkiye and one of the biggest in the world, respectively carries porcelain slab to new usage areas with its large sizes, thin form, light structure, and environmentally-friendly production technology.

Dr. (h.c.) İbrahim Bodur tarafından 1957 yılında kurulan Çanakkale Seramik Fabrikaları A.Ş. ile temelleri atılan Kale Grubu, seramik üretimi ile başladığı sanayi yolculuğunda zamanla yapı kimyasalları, lojistik, havacılık sanayiine uzanan bir gelişim yaşadı. Günümüzde, 5 bini aşkın çalışanıyla Kale Grubu, Çanakkale başta olmak üzere Türkiye'nin çeşitli bölgelerinde bulunuyor. Türkiye'de seramik sektörünün kuruluşuna öncülük eden Kaleseramik, bu topraklarda üreten, bu topraklardan kazandığını yine bu topraklara yatıran bir değer.

Türkiye'nin ilk seramik karo üreticisi olan Çanakkale Seramik Fabrikaları A.Ş. 1957 yılında, ilk yer karosu üreticisi olan Kalebodur Seramik Sanayi A.Ş. ise 1972 yılında kuruldu. Çanakkale Seramik, duvar karosunda kalitenin adı olurken, Kalebodur jenerik marka olarak sektörde yeni bir dönemi başlattı.

Çanakkale Seramik Fabrikaları A.Ş ve Kalebodur Seramik Sanayi A.Ş. 2000 yılında "Kaleseramik Çanakkale Kalebodur Seramik Sanayi A.Ş" ismiyle tek çatı altında birleşti. Çanakkale Seramik ve Kalebodur markaları ile üretimini sürdüren Kaleseramik üretim kapasitesi ile tek bir alanda üretim yapan dünyanın en büyük seramik kuruluşudur.

Türkiye'nin 1., dünyanın en büyük seramik üreticilerinden biri olan Kaleseramik uzmanlığıyla 2005 yılında geliştirilen Kalesinterflex Porselen plaka; büyük ebatları, ince formu, hafif yapısı ve çevreci üretim teknolojisiyle seramiği yeni kullanım alanlarına taşıyor.

With the new investment made in 2023, Kalesinterflex, which will be produced with the dimensions of 160x320cm, 6mm, 12mm, and 20mm thicknesses, as well as matte, satin, and polished surface options, is getting ready to put its stamp on the innovations that will revolutionize architecture.

2023 yılında hayata geçirilen yeni yatırımla 160x320cm büyüklüğünde, 6mm, 12mm, 20mm inceliğinde, mat, satin ve parlak yüzey alternatifleriyle üretilecek olan Kalesinterflex; mimaride devrim etkisi yaratacak yeniliklere imza atmaya hazırlanıyor.





Human Factor

İnsan Faktörü

Beginning in 6000 BC, this journey opens the doors to worlds waiting to be discovered with cutting-edge technology.

As Kaleseramik, we combine tradition, innovation, creativity, and craftsmanship for a unique form and functionality. Each new day brings novelty to our work, and our passion for ceramics grows daily, giving meaning to living spaces.

Because we know ceramic takes shape in the right hands. Thanks to its industrialist heritage and entrepreneurship, it continues economic and social activities with the priority of being a reputable group of companies that is a pioneer in its field, respects people and the environment, and adds sustainable value to society.

*Milattan önce 6000'li yıllarda başlayan bu yolculuk, yenilikçi teknolojiyle keşfedilmeyi bekleyen dünyaların kapılarını açıyor.
Benzersiz bir form ve fonksiyonellik için Kaleseramik olarak gelenekle yeniliği, yaratıcılıkla zanaati buluşturuyoruz.
Her yeni gün işimize de yenilik katıyor ve seramiğe duyduğumuz tutkuyu günden güne büyütüyor, yaşayan mekanlara anlam katıyoruz.*

*Çünkü seramiğin doğru ellerde şekil aldığını biliyoruz.
Sanayici mirası ve girişimciliği ile alanında önder, insana ve çevreye saygılı, topluma sürdürülebilir değer katan itibarlı şirketler grubu olma önceliğiyle ekonomik ve toplumsal faaliyetlerine devam ediyor.*

KALESINTERFLEX SUPERIOR TECHNOLOGIES

Kalesinterflex Üstün Yüzey Teknolojileri

◦ **DECOTECH**

◦ **BODYTECH**

◦ **FLOWTECH**

◦ **GLOWTECH**

◦ **FORMTECH**

◦ **OPENBOOK**



DECOTECH

The Technology Of Art

Sanatın Teknolojisi



DECOTECH technology, which stands out due to the application of special materials to the surfaces and their separation from flatly printed products, and matte or glossy materials bearing the name of granilla create a striking relief effect on the products.

Reliefs, which can be applied synchronously or independently according to different design needs and wishes, are often preferred in decorative and positive spaces.

Yüzeyle özel malzemelerin uygulanması ve düz baskılı ürünlerden ayrıştırılmasıyla öne çıkan DECOTECH teknolojisi, granilya adını taşıyan mat veya parlak malzemeler, ürünlerde çarpıcı bir kabartma etkisi oluşturur.

Farklı tasarım ihtiyaçlarına ve isteklere göre senkronize veya bağımsız olarak uygulanabilen kabartmalar, dekoratif ve pozitif mekanlarda sıklıkla tercih edilir.



BODYTECH

The Technology Of Consistency

Devamlılığın Teknolojisi



BODYTECH technology, which refers to the use of salt-pepper-mas in traditional porcelain production, is constituted from finely ground mas mixtures containing homogeneous stone textures and different color shades on the surface of the products. Thanks to the special method that carries the visual effect on the surface of the product to the product structure, each edge and each cut point of the product offers a harmonious and holistic appearance with the surface.

Geleneksel porselen üretimindeki tuz biber masse kullanımını ifade eden BODYTECH teknolojisi, ürünlerin yüzeyinde homojen taş dokusu ve farklı renk tonlarını içeren ince öğütülmüş masse karışımlarıyla oluşturulur. Ürünün yüzeyindeki görsel etkiyi ürün bünyesine taşıyan özel yöntemle, ürünün her bir kenarı ve kesilen her noktası, yüzeyle uyumlu ve bütünsel bir görünüm sunar.

FLOWTECH

The Technology Of Eternity

Sonsuzluğun Teknolojisi



FLOWTECH, used as a pattern tracking technology, ensures the progression of the pattern between the panels of marble-look products in particular. It creates a more impressive ambiance in wall applications in spaces. Some marble products were designed using this method. However, during the production phase, the products are produced in a combination. Practitioners should make the right choice during the covering to capture this flow. Thus, the aesthetic and design potential of the space is maximized.

Desen takip teknolojisi olarak kullanılan FLOWTECH, özellikle mermer görümlü ürünlerin panelleri arasındaki desenin devamlılığını sağlar. Mekanlardaki duvar kullanımlarında daha etkileyici bir atmosfer oluşturur. Bazı mermer ürünleri bu yöntemle tasarlanmıştır, ancak üretim aşamasında ürünler karma şekilde üretilir. Bu akışı yakalamak için döşeme sırasında uygulayıcıların doğru seçim yapması gerekmektedir. Böylece mekanın estetik ve tasarım potansiyeli en üst düzeye çıkar.

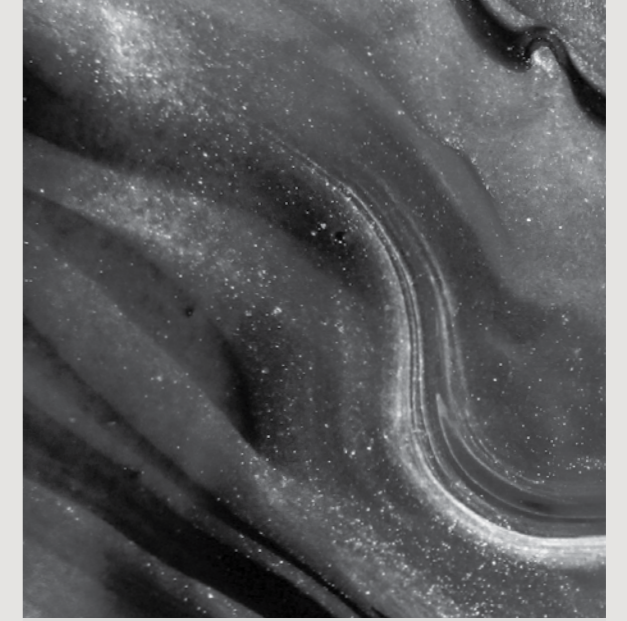

GLOWTECH

The Technology Of Sparkle

Işıltının Teknolojisi



GLOWTECH, used as a glitter/bright luminescence technology, refers to the effect caused by the glare of micro pieces on the surface of glossy products. This special effect gives the products a more exclusive and eye-catching glow by distinguishing them from standard glossy ones. While it is described as the reflection of the natural mineral glow in some marbles on the ceramic technology, an aesthetic and elegant shine is obtained in the spaces.

Simli/parlak ışıltılar teknolojisi olarak kullanılan GLOWTECH, parlak ürünlerde yüzeydeki mikro parçaların parlamasıyla oluşan etkiyi tanımlar. Bu özel etki, ürünleri standart parlaklardan ayırarak daha özel ve göz alıcı bir ışıltıya kavuşturur. Bazı mermerlerde bulunan doğal mineral ışıltılarının seramik teknolojisine yansımış hali olarak da nitelendirilirken, mekanlarda estetik ve zarif bir parlaklık elde edilir.

OPENBOOK

The Technology Of Symmetry

Simetri Teknolojisi



OPENBOOK, used as a Correspondent Pattern Technology, enables one module to come face to face with the other module and create a unique pattern, especially in marble-look products. This special design distinguishes both modules as A and B with different codes while allowing small pattern shifts of 1-2 cm between them. Thanks to this method, aesthetic and visual diversity is achieved in spaces, and the integrity of the design is preserved.

Karşılıklı Desen Teknolojisi olarak kullanılan OPENBOOK, özellikle mermer görünümlü ürünlerde, bir modülün diğer modül ile yüz yüze gelerek özgün bir desen oluşturmasını sağlar. Bu özel tasarım, modüller arasında 1-2 cm gibi küçük desen kaymalarına izin verirken, her iki modülü de A ve B olarak farklı kodlarla ayırt eder. Bu yöntem sayesinde mekanlarda estetik ve görsel çeşitlilik elde edilirken, tasarımın bütünlüğü korunur.

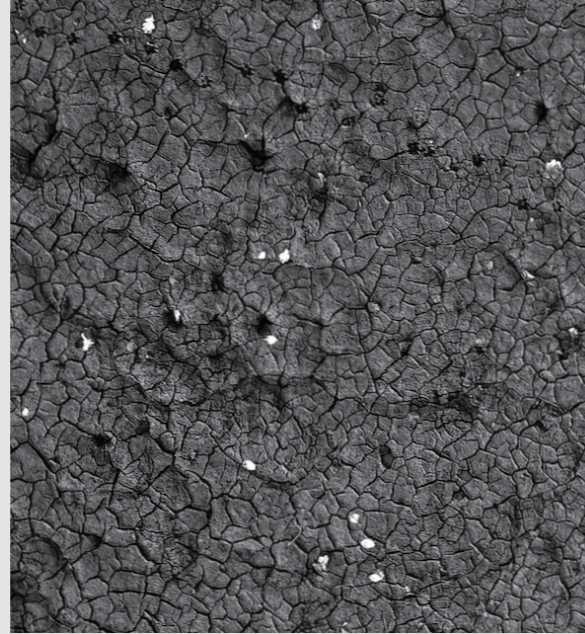

FORMTECH

The Technology Of Sensation

Dokunun Teknolojisi



Porcelain slabs mimicking the appearance of natural stone carry aesthetic elegance to living spaces. FORMTECH shapes porcelain slabs with inspiration from nature.

Bringing surfaces an embossed and ragged feel, FORMTECH technology adds depth to spaces. Special surfaces adapted to different patterns, textures and colors offer visual richness to living spaces. It creates a more attractive and unique atmosphere in every space.

Yüzeyle kabartmalı ve pütürlü bir dokunuş hissiyatı kazandıran FORMTECH teknolojisi, mekanlara derinlik ekler. Farklı desen ve renklere uyarlanan özel yüzeyler, yaşam alanlarına görsel zenginlik sunar. Her mekanda daha çekici ve özgün bir atmosfer yaratır.



Spaces

Alanlar

Your home is your world.

Creating aesthetically pleasing and stylish products that fit seamlessly into your world is our world.

Crafted with attention to detail and pride, we collaborate with creators and manufacturers with similar passions. All to be a breath of fresh air in living spaces.

Eviniz, sizin dünyanız.

Sizin dünyanıza uyum sağlayacak estetik ve şık ürünler tasarlamak da bizim dünyamız. Detaylarla mükemmelleştirilmiş bir işçilik, benzer tutkuları paylaştığımız yaratıcılar ve üreticilerle yaptığımız işbirlikleri. Hepsî yaşayan mekanlara taptaze bir nefes olmak için.



EARTH COLLECTION/TRAVERTINE SILVER
EARTH KOLEKSİYONU/TRAVERTINE SILVER



FIORI DI BOSCO



MARMO METALLO

Bathroom

Banyo



CRYSTALLUS



DENISE



CRYSTALLUS

Bathroom

Banyo



Kitchen

Mutfak



TRAVERTINE SILVER



OLIMPO



PIETRA NERO

Interior

İç Mekan



CALACATTA GOLD



CRYSTALLUS



EARTH COLLECTION
EARTH KOLEKSİYONU



Exterior

Dış Mekan

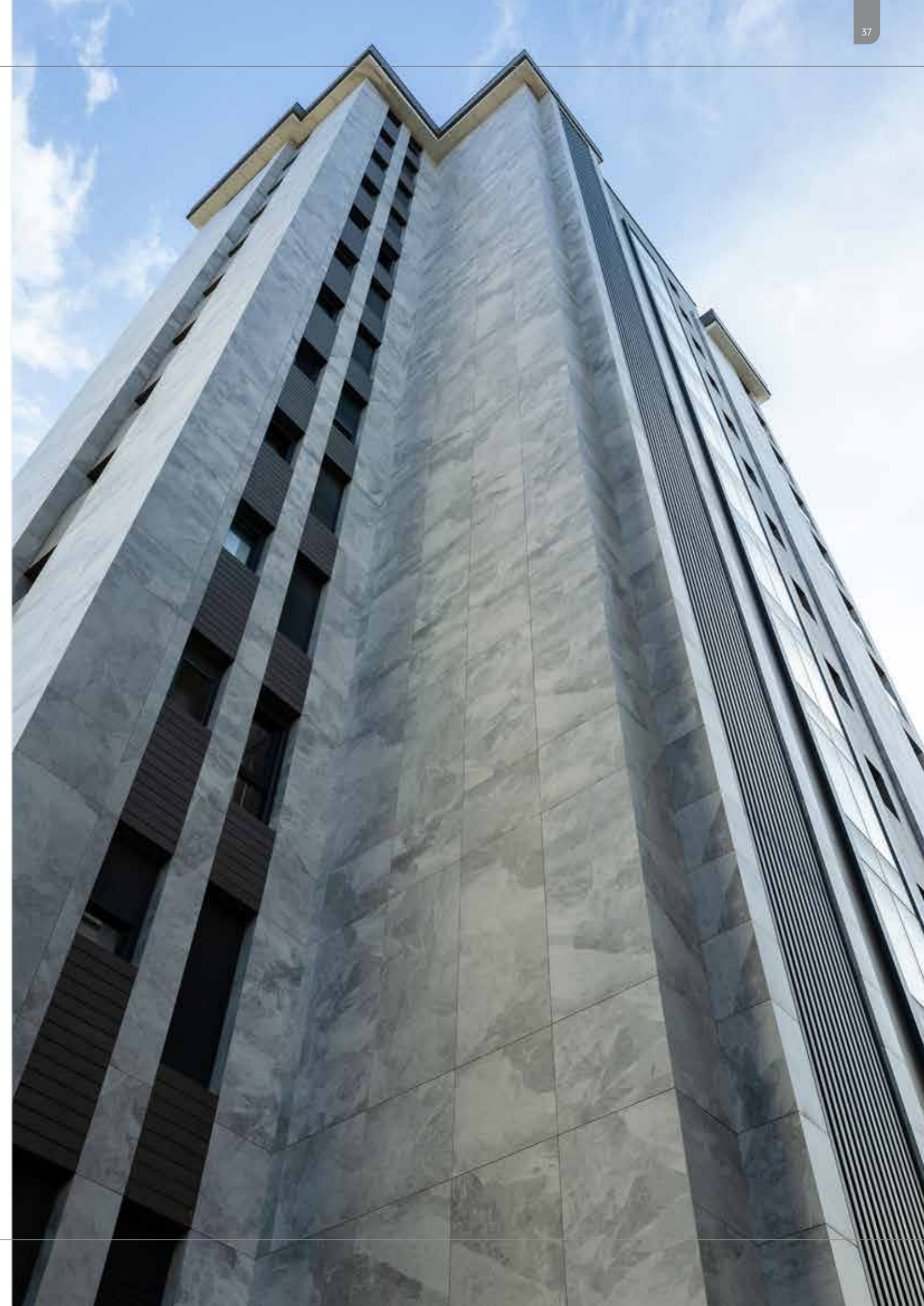

Marble Look

Mermer Görünüm

The timeless beauty of marble inspires high-tech porcelain slabs. Each curve and pattern created by the hand of nature turns these rare slabs into sustainable works of art.

Mermerin zamana karşı koyan güzelliği, yüksek teknolojinin eseri porselen plakalara ilham veriyor. Doğanın eliyle yaratılan her bir kıvrım ve deseni birer sanat eserine çeviriyor.

100x300 - 3mm • 120x360 - 3mm • 160x320 - 6mm •
162x323 - 6mm - 12mm - 20mm - 5mm - 3mm

Wood Look

Ahşap Görünüm

When the simplicity and naturalness of a wood-like appearance come together, elegant porcelain plates are prepared for spaces, creating perfect beauty.

Ahşap görünümünün sadeliği ve doğallığı buluştuğunda mekanlar için şık porselen plakalar hazırlanarak kusursuz bir güzellik yaratılıyor.

100x300 - 3mm • 120x360 - 3mm

Solid Color

Düz Renkler

A striking simplicity. For a refined look, it creates subtle, broad, sophisticated surfaces that leave a lasting impression.

Çarpıcı bir sadelik. Rafine bir görünüm için incelikli, geniş, sürekli etki bırakan incelikli yüzeyler yaratır.

100x300 - 3mm • 120x360 - 3mm • 160x320 - 6mm •
162x323 - 6mm - 12mm

Stone Look

Doğaltaş Görünüm

The original and rare beauty of natural stone meets the extraordinary durability of porcelain slab. The optimal and aesthetic interpretation of the materials given by nature provides a characterful perfection to spaces.

Doğal taşın orijinal ve nadir güzelliği, porselen plakanın olağanüstü dayanıklılığıyla buluşuyor. Doğanın verdiği malzemelerin en ideal ve estetik bir şekilde yorumlanmasıyla oluşan bu görünüm mekanlara karakterli bir kusursuzluk katıyor.

100x300 - 3mm • 120x360 - 3mm • 160x320 - 6mm •
162x323 - 6mm - 12mm - 20mm

Metal Look

Metal Görünüm

The mineral beauty of metals is revitalized and deepened with large porcelain slabs that allow for stunning designs. These products bring the ideal solution for spaces designed with contemporary architecture.

Metallerin mineral güzelliği yeniden hayat buluyor ve çarpıcı tasarımlara olanak veren büyük porselen plakalarla derinlik kazanıyor. Bu ürünler, çağdaş mimariye sahip mekanlar için ideal çözüm sunuyor.

100x300 - 3mm • 120x360 - 3mm • 160x320 - 6mm • 162x323 - 6mm - 12mm

Cement Look

Çimento Görünüm

Cement, the unsung hero of every endeavor, weaves a magical beauty with its cement-like appearance on porcelain plates. An extraordinary touch that beautifies and gives character to a structure.

Çimento, her projenin gizli kahramanıdır; porselen plakaların üzerindeki çimento görünümü, büyümlü bir estetik yaratır. Bir yapıyı güzelleştiren ve ona karakter katan sıradışı bir dokunuş.

100x300 - 3mm • 120x360 - 3mm • 160x320 - 6mm •
162x323 - 6mm - 12mm - 20mm



Artwall

Artwall

Artwall'un artistik görünümlü porselen plakaları, teknoloji ve estetiği bir araya getiriyor. Doğanın zarafetini taşıyan desenleri, yaşam alanlarınızı adeta bir sanat galerisine çeviriyor.

Artwall's porcelain slabs with artistic looks bring together technology and aesthetics. Their patterns that bear the elegance of nature transform your living spaces into a kind of art gallery.

160x320 - 6mm • 162x323 - 6mm - 12mm - 20mm

MARBLE LOOK
MERMER GÖRÜNÜM



Marble Look

Mermer Görünüm



PIETRA NERO



CRYSTALLUS

Marble Look

Mermer Görünüm



CALACATTA UNIQUE OPENBOOK



ALASKA WHITE

Marble | Black & White

Mermer | Siyah & Beyaz

new
yeni

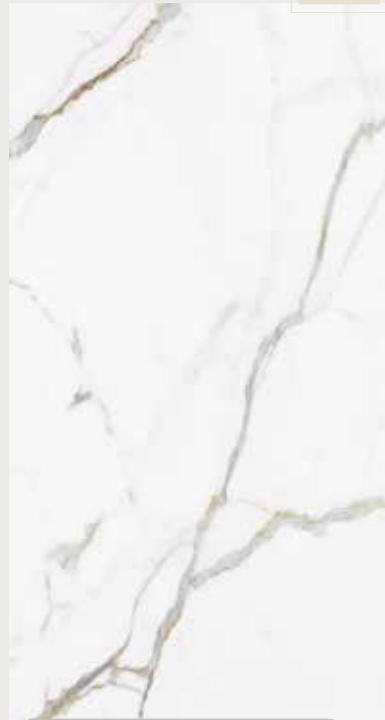

CALACATTA UNIQUE

	mm	Matte	Soft Matte	Polished	Satin	Face
100x300 cm	3	•				
	5	•				
120x360 cm	3	•				
	5	•				
160x320 cm 162x323 cm	6		•	•		3F
	12		•	•	•	
	20		•	•		

FLOW
TECH

new
yeni



CALACATTA UNIQUE OPENBOOK

	mm	Matte	Soft Matte	Polished	Satin	Face
100x300 cm	3					
	5					
120x360 cm	3					
	5					
160x320 cm 162x323 cm	6		•	•		
	12		•	•		
	20		•	•		

FLOW
TECH

OPEN
BOOK

new
yeni



GOLDEN HOUR

	mm	Matte	Soft Matte	Polished	Satin	Face
100x300 cm	3					
	5					
120x360 cm	3					
	5					
160x320 cm 162x323 cm	6		•	•		3F
	12		•	•		
	20		•	•		

FLOW
TECH

new
yeni



GOLDEN HOUR OPENBOOK

	mm	Matte	Soft Matte	Polished	Satin	Face
100x300 cm	3					
	5					
120x360 cm	3					
	5					
160x320 cm 162x323 cm	6		•	•		
	12		•	•		
	20		•	•		

FLOW
TECH

OPEN
BOOK



100x300 cm, 120x360 cm and 160x320 cm are rectified sizes.
100x300 cm, 120x360 cm ve 160x320 cm ebatlar karelenmiş ebatlardır.

Please check pages between 146-155 for dimension detail chart.

Ebat tablosu için 146-151 sayfaları arasına bakınız.

The use of polished products in areas with heavy pedestrian traffic is not recommended.
Parlak ürünlerin yoğun yaya trafiği olan alanlarda kullanımı önerilmez.



100x300 cm, 120x360 cm and 160x320 cm are rectified sizes.
100x300 cm, 120x360 cm ve 160x320 cm ebatlar karelenmiş ebatlardır.

Please check pages between 146-155 for dimension detail chart.

The use of polished products in areas with heavy pedestrian traffic is not recommended.
Parlak ürünlerin yoğun yaya trafiği olan alanlarda kullanımı önerilmez.

Ebat tablosu için 146-151 sayfaları arasına bakınız.

Marble | Black & White

Mermer | Siyah & Beyaz

new
yeni



FLORENCE

	mm	Matte	Soft Matte	Polished	Satin	Face
100x300 cm	3 5					
120x360 cm	3 5					
160x320 cm 162x323 cm	6 12 20		•	•		3F

FLOW
TECH

new
yeni



FLORENCE OPENBOOK

	mm	Matte	Soft Matte	Polished	Satin	Face
100x300 cm	3 5					
120x360 cm	3 5					
160x320 cm 162x323 cm	6 12 20		•	•		

FLOW
TECH

OPEN
BOOK

new
yeni



COLORADO ORO

	mm	Matte	Soft Matte	Polished	Satin
100x300 cm	3 5	•			
120x360 cm	3 5				
160x320 cm 162x323 cm	6 12 20				

	mm	Matte	Soft Matte	Polished	Satin
100x300 cm	3 5	•			
120x360 cm	3 5				
160x320 cm 162x323 cm	6 12 20				

OPEN
BOOK



Interior & Design



Facade



Kitchen



Furniture



Bathroom



Indoor



Outdoor



Commercial



Gleaming



Wall



Floor



Moderate Variation



Face sayısı belirtilmektedir.



Interior & Design



Facade



Kitchen



Furniture



Bathroom



Indoor



Outdoor



Commercial



Gleaming



Wall



Floor



Uniform Appearance



Face sayısı belirtilmektedir.

100x300 cm, 120x360 cm and 160x320 cm are rectified sizes.
100x300 cm, 120x360 cm ve 160x320 cm ebatlar karelenmiş ebatlardır.

Please check pages between 146-155 for dimension detail chart.

Ebat tablosu için 146-151 sayfaları arasına bakınız.

The use of polished products in areas with heavy pedestrian traffic is not recommended.
Parlak ürünlerin yoğun yaya trafiği olan alanlarda kullanımı önerilmez.

100x300 cm, 120x360 cm and 160x320 cm are rectified sizes.
100x300 cm, 120x360 cm ve 160x320 cm ebatlar karelenmiş ebatlardır.

Please check pages between 146-155 for dimension detail chart.

The use of polished products in areas with heavy pedestrian traffic is not recommended.
Parlak ürünlerin yoğun yaya trafiği olan alanlarda kullanımı önerilmez.

Ebat tablosu için 146-151 sayfaları arasına bakınız.

Marble | Black & White

Mermer | Siyah & Beyaz

new
yeni



PIETRA NERO

	mm	Matte	Soft Matte	Polished	Satin	Face
100x300 cm	3 5	•				
120x360 cm	3 5	•				
160x320 cm 162x323 cm	6 12 20		•	•		3F

new
yeni

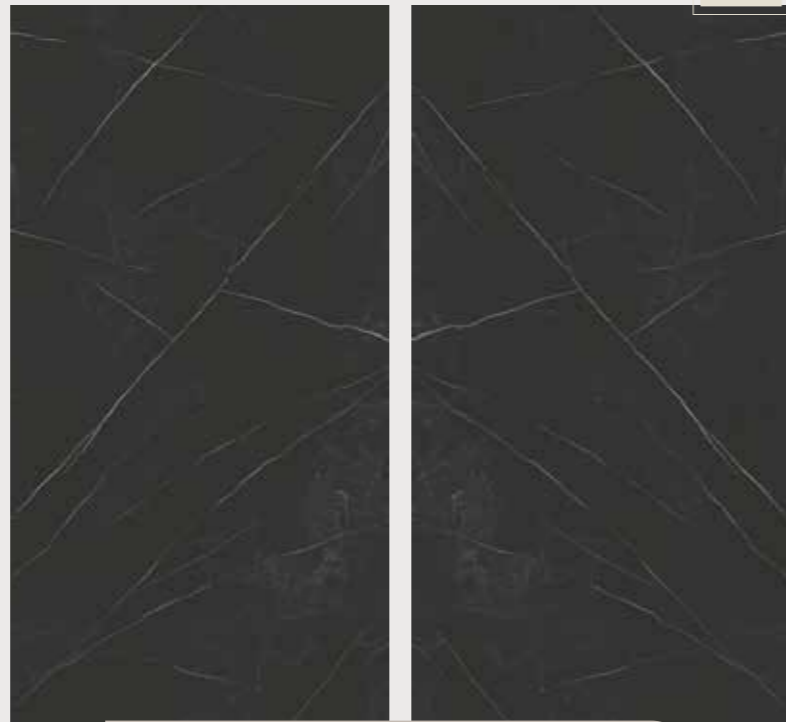

PIETRA NERO OPENBOOK

	mm	Matte	Soft Matte	Polished	Satin	Face
100x300 cm	3 5					
120x360 cm	3 5					
160x320 cm	6 12 20		•	•		

OPEN
BOOK

new
yeni



CALACATTA CALDIA

	mm	Matte	Soft Matte	Polished	Satin	Face
100x300 cm	3 5	•				
120x360 cm	3 5	•				
160x320 cm 162x323 cm	6 12 20		•	•	•	3F

new
yeni



BRONZE LINE

	mm	Matte	Soft Matte	Polished	Satin	Face
100x300 cm	3 5					
120x360 cm	3 5					
160x320 cm 162x323 cm	6 12 20		•	•		3F

new
yeni



CALACATTA GOLD*

	mm	Matte	Soft Matte	Polished	Satin	Face
100x300 cm	3 5	•				
120x360 cm	3 5	•				
160x320 cm 162x323 cm	6 12 20		•	•	•	3F

DECO
TECH



*Gleaming Surface: Regional shiny / sparkle effect on matte surface.
Parıltılı Yüzey: Mat yüzey üzerinde bölgesel ışıltı / parıltı efekti.



Interior &
Design



Facade



Kitchen



Furniture



Bathroom



Indoor



Outdoor



Commercial



Gleaming



Wall



Floor



Moderate
Variation



Face sayısını
belirtmektedir.



Interior &
Design



Facade



Kitchen



Furniture



Bathroom



Indoor



Outdoor



Commercial



Gleaming



Wall



Floor



Moderate
Variation



Face sayısını
belirtmektedir.

100x300 cm, 120x360 cm and 160x320 cm are rectified sizes.
100x300 cm, 120x360 cm ve 160x320 cm ebatlar karelenmiş ebatlardır.

Please check pages between 146-155 for dimension detail chart.

Ebat tablosu için 146-151 sayfaları arasına bakınız.

The use of polished products in areas with heavy pedestrian traffic is not recommended.
Parlak ürünlerin yoğun yaya trafiği olan alanlarda kullanımı önerilmez.

100x300 cm, 120x360 cm and 160x320 cm are rectified sizes.
100x300 cm, 120x360 cm ve 160x320 cm ebatlar karelenmiş ebatlardır.

Please check pages between 146-155 for dimension detail chart.

Ebat tablosu için 146-151 sayfaları arasına bakınız.

The use of polished products in areas with heavy pedestrian traffic is not recommended.
Parlak ürünlerin yoğun yaya trafiği olan alanlarda kullanımı önerilmez.

Marble | Black & White

Mermer | Siyah & Beyaz

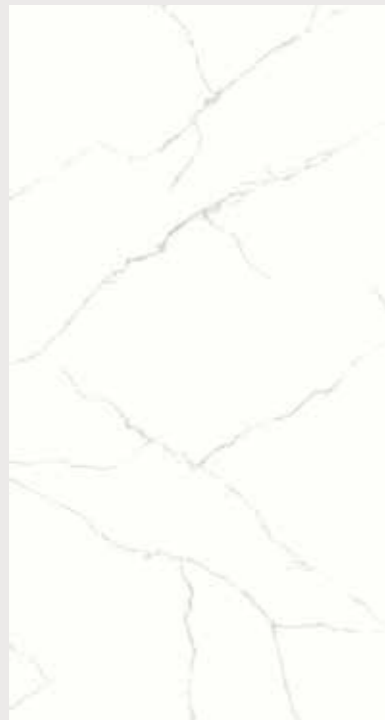

MARBLE STATUARIO

	mm	Matte	Soft Matte	Polished	Satin
100x300 cm	3 5				
120x360 cm	3 5				
160x320 cm 162x323 cm	6 12 20		•	•	



CALACATTA ICE

	mm	Matte	Soft Matte	Polished	Satin
100x300 cm	3 5	•			
120x360 cm	3 5	•			
160x320 cm 162x323 cm	6 12 20				



PALISSANDRO*

	mm	Matte	Soft Matte	Polished	Satin	Face
100x300 cm	3 5	•	•			
120x360 cm	3 5	•	•			
160x320 cm 162x323 cm	6 12 20		•			4F

DECO
TECH



CALACATTA 2.0

	mm	Matte	Soft Matte	Polished	Satin	Face
100x300 cm	3 5	•				3F
120x360 cm	3 5	•				3F
160x320 cm 162x323 cm	6 12 20					



CALACATTA MACCHIA

	mm	Matte	Soft Matte	Polished	Satin
100x300 cm	3 5	•			
120x360 cm	3 5	•			
160x320 cm 162x323 cm	6 12 20		•	•	3F

DECO
TECH



CALACATTA VIOLA

	mm	Matte	Soft Matte	Polished	Satin
100x300 cm	3 5				
120x360 cm	3 5				
160x320 cm 162x323 cm	6 12 20			•	

new
yeni

*Gleaming Surface: Regional shiny / sparkle effect on matte surface.
Parıltılı Yüzey: Mat yüzey üzerinde bölgesel ışıltı / parıltı efekti.



Interior & Design



Facade



Kitchen



Furniture



Bathroom



Indoor



Outdoor



Commercial



Gleaming



Wall



Floor



Moderate Variation



Face sayısını belirtmektedir.



Interior & Design



Facade



Kitchen



Furniture



Bathroom



Indoor



Outdoor



Commercial



Gleaming



Wall



Floor



Moderate Variation



Face sayısını belirtmektedir.

100x300 cm, 120x360 cm and 160x320 cm are rectified sizes.
100x300 cm, 120x360 cm ve 160x320 cm ebatlar karelenmiş ebatlardır.

Please check pages between 146-155 for dimension detail chart.

The use of polished products in areas with heavy pedestrian traffic is not recommended.
Parlak ürünlerin yoğun yaya trafiği olan alanlarda kullanımı önerilmez.

Ebat tablosu için 146-151 sayfaları arasına bakınız.

100x300 cm, 120x360 cm and 160x320 cm are rectified sizes.
100x300 cm, 120x360 cm ve 160x320 cm ebatlar karelenmiş ebatlardır.

Please check pages between 146-155 for dimension detail chart.

The use of polished products in areas with heavy pedestrian traffic is not recommended.
Parlak ürünlerin yoğun yaya trafiği olan alanlarda kullanımı önerilmez.

Ebat tablosu için 146-151 sayfaları arasına bakınız.

Marble | Black & White

Mermer | Siyah & Beyaz



WINTERLAND

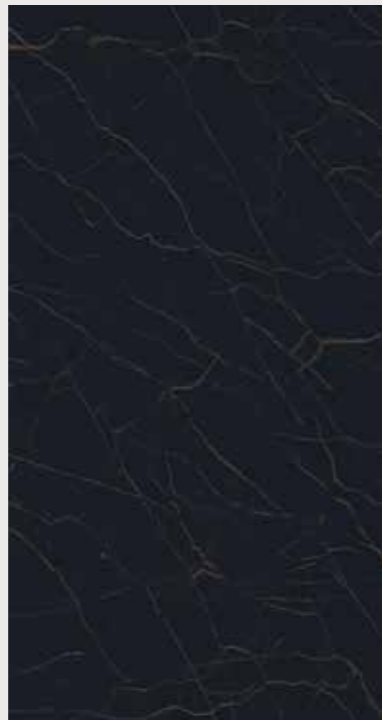

PORT LAURENT

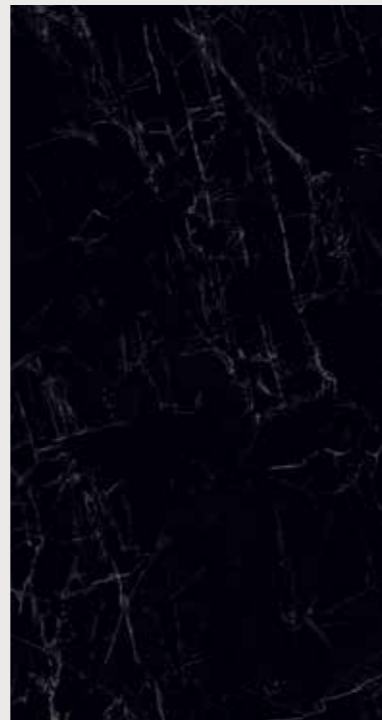

MARBLE DARK

	mm	Matte	Soft Matte	Polished	Satin
100x300 cm	3	•			
	5	•			
120x360 cm	3	•			
	5	•			
160x320 cm 162x323 cm	6				
	12				
	20				

	mm	Matte	Soft Matte	Polished	Satin	Face
100x300 cm	3	•				
	5	•				
120x360 cm	3	•				
	5	•				
160x320 cm 162x323 cm	6		•	•		2F
	12		•	•		
	20		•	•		

	mm	Matte	Soft Matte	Polished	Satin
100x300 cm	3	•			
	5	•			
120x360 cm	3	•			
	5	•			
160x320 cm 162x323 cm	6				
	12				
	20				



Interior & Design



Facade



Kitchen



Furniture



Bathroom



Indoor



Outdoor



Commercial



Gleaming



Wall



Floor



Moderate Variation



Face sayısını belirtmektedir.

100x300 cm, 120x360 cm and 160x320 cm are rectified sizes.
100x300 cm, 120x360 cm ve 160x320 cm ebatlar karelenmiş ebatlardır.

Please check pages between 146-155 for dimension detail chart.

Ebat tablosu için 146-151 sayfaları arasına bakınız.

The use of polished products in areas with heavy pedestrian traffic is not recommended.
Parlak ürünlerin yoğun yaya trafiği olan alanlarda kullanımı önerilmez.

Marble | Exclusive

Mermer | Özel

new
yeni



PATAGONIA

	mm	Matte	Soft Matte	Polished	Satin	Face
100x300 cm	3					
	5					
120x360 cm	3					
	5					
160x320 cm 162x323 cm	6		•	•		3F
	12		•	•		
	20		•	•		

FLOW
TECH

new
yeni



PATAGONIA OPENBOOK

	mm	Matte	Soft Matte	Polished	Satin	Face
100x300 cm	3					
	5					
120x360 cm	3					
	5					
160x320 cm 162x323 cm	6		•	•		
	12		•	•		
	20		•	•		

FLOW
TECH OPEN
BOOK



Interior & Design



Facade



Kitchen



Furniture



Bathroom



Indoor



Outdoor



Commercial



Gleaming



Wall



Floor



Moderate Variation



Face sayısını belirtmektedir.

100x300 cm, 120x360 cm and 160x320 cm are rectified sizes.
100x300 cm, 120x360 cm ve 160x320 cm ebatlar karelenmiş ebatlardır.

Please check pages between 146-155 for dimension detail chart.

Ebat tablosu için 146-151 sayfaları arasına bakınız.

The use of polished products in areas with heavy pedestrian traffic is not recommended.
Parlak ürünlerin yoğun yaya trafiği olan alanlarda kullanımı önerilmez.

Marble | Exclusive

Mermer | Özel



QUARZITE JADORE



QUARZITE JADORE OPENBOOK

	mm	Matte	Soft Matte	Polished	Satin	Face
100x300 cm	3					
	5					
120x360 cm	3					
	5					
160x320 cm 162x323 cm	6			•		3F
	12			•		
	20					

	mm	Matte	Soft Matte	Polished	Satin	Face
100x300 cm	3					
	5					
120x360 cm	3					
	5					
160x320 cm	6			•		
	12			•		
	20					



100x300 cm, 120x360 cm and 160x320 cm are rectified sizes.
100x300 cm, 120x360 cm ve 160x320 cm ebatlar karelenmiş ebatlardır.

The use of polished products in areas with heavy pedestrian traffic is not recommended.
Parlak ürünlerin yoğun yaya trafiği olan alanlarda kullanımı önerilmez.

Please check pages between 146-155 for dimension detail chart.

Ebat tablosu için 146-151 sayfaları arasına bakınız.

new
yeni

TIFFANY BLUE

	mm	Matte	Soft Matte	Polished	Satin	Face
100x300 cm	3					
	5					
120x360 cm	3					
	5					
160x320 cm 162x323 cm	6			•		3F
	12					
	20					

new
yeni

TIFFANY BLUE OPENBOOK

	mm	Matte	Soft Matte	Polished	Satin	Face
100x300 cm	3					
	5					
120x360 cm	3					
	5					
160x320 cm	6			•		
	12					
	20					



100x300 cm, 120x360 cm and 160x320 cm are rectified sizes.
100x300 cm, 120x360 cm ve 160x320 cm ebatlar karelenmiş ebatlardır.

The use of polished products in areas with heavy pedestrian traffic is not recommended.
Parlak ürünlerin yoğun yaya trafiği olan alanlarda kullanımı önerilmez.

Please check pages between 146-155 for dimension detail chart.

Ebat tablosu için 146-151 sayfaları arasına bakınız.

Marble | Exclusive

Mermer | Özel

new
yeni

NAMIBIA

	mm	Matte	Soft Matte	Polished	Satin	Face
100x300 cm	3					
	5					
120x360 cm	3					
	5					
160x320 cm 162x323 cm	6			•		3F
	12			•		
	20			•		

FLOW
TECHnew
yeni

ALASKA WHITE

	mm	Matte	Soft Matte	Polished	Satin	Face
100x300 cm	3					
	5					
120x360 cm	3					
	5					
160x320 cm 162x323 cm	6			•		3F
	12			•		
	20			•		

FLOW
TECHSAHARA BROWN
SAHARA KAHVE

	mm	Matte	Soft Matte	Polished	Satin	Face
100x300 cm	3	•				
	5					
120x360 cm	3					
	5					
160x320 cm 162x323 cm	6		•			3F
	12		•			
	20		•			

new
yeni

MARINA

	mm	Matte	Soft Matte	Polished	Satin	Face
100x300 cm	3					
	5					
120x360 cm	3					
	5					
160x320 cm 162x323 cm	6			•		3F
	12			•		
	20			•		

FLOW
TECH

SEA NATURE

	mm	Matte	Soft Matte	Polished	Satin	Face
100x300 cm	3	•				
	5					
120x360 cm	3					
	5					
160x320 cm 162x323 cm	6					
	12					
	20					

Interior &
Design

Facade



Kitchen



Furniture



Bathroom



Indoor



Outdoor



Commercial



Gleaming



Wall



Floor

Moderate
VariationFace sayısını
belirtmektedir.

100x300 cm, 120x360 cm and 160x320 cm are rectified sizes.
100x300 cm, 120x360 cm ve 160x320 cm ebatlar karelenmiş ebatlardır.

The use of polished products in areas with heavy pedestrian traffic is not recommended.
Parlak ürünlerin yoğun yaya trafiği olan alanlarda kullanımı önerilmez.

Please check pages between 146-155 for dimension detail chart.

Ebat tablosu için 146-151 sayfaları arasına bakınız.

Interior &
Design

Facade



Kitchen



Furniture



Bathroom



Indoor



Outdoor



Commercial



Gleaming



Wall



Floor

Moderate
VariationFace sayısını
belirtmektedir.

100x300 cm, 120x360 cm and 160x320 cm are rectified sizes.
100x300 cm, 120x360 cm ve 160x320 cm ebatlar karelenmiş ebatlardır.

The use of polished products in areas with heavy pedestrian traffic is not recommended.
Parlak ürünlerin yoğun yaya trafiği olan alanlarda kullanımı önerilmez.

Please check pages between 146-155 for dimension detail chart.

Ebat tablosu için 146-151 sayfaları arasına bakınız.

Marble | Exclusive

Mermer | Özel

new
yeni

SARRANCOLIN



MARMO METALLO*



VERSAILLES



ASTEROID



MOCHA PERLA



OLIMPO

	mm	Matte	Soft Matte	Polished	Satin	Face
100x300 cm	3 5					
120x360 cm	3 5					
160x320 cm 162x323 cm	6 12 20		•	•		3F

	mm	Matte	Soft Matte	Polished	Satin	Face
100x300 cm	3 5	•				
120x360 cm	3 5	•				
160x320 cm 162x323 cm	6 12 20		•			3F

	mm	Matte	Soft Matte	Polished	Satin	Face
100x300 cm	3 5					
120x360 cm	3 5					
160x320 cm 162x323 cm	6 12 20		•	•		

	mm	Matte	Soft Matte	Polished	Satin	Face
100x300 cm	3 5	•				5F
120x360 cm	3 5	•				5F
160x320 cm 162x323 cm	6 12 20					

	mm	Matte	Soft Matte	Polished	Satin	Face
100x300 cm	3 5	•				
120x360 cm	3 5	•				
160x320 cm 162x323 cm	6 12 20					

	mm	Matte	Soft Matte	Polished	Satin	Face
100x300 cm	3 5	•				
120x360 cm	3 5	•				
160x320 cm 162x323 cm	6 12 20		•	•		3F

FLOW
TECHFLOW
TECH DECO
TECH

Interior & Design



Facade



Kitchen



Furniture



Bathroom



Indoor



Outdoor



Commercial



Gleaming



Wall



Floor



Moderate Variation



Face sayısını belirtmektedir.



Interior & Design



Facade



Kitchen



Furniture



Bathroom



Indoor



Outdoor



Commercial



Gleaming



Wall



Floor



Moderate Variation



Face sayısını belirtmektedir.

100x300 cm, 120x360 cm and 160x320 cm are rectified sizes.
100x300 cm, 120x360 cm ve 160x320 cm ebatlar karelenmiş ebatlardır.

Please check pages between 146-155 for dimension detail chart.

Ebat tablosu için 146-151 sayfaları arasına bakınız.

The use of polished products in areas with heavy pedestrian traffic is not recommended.
Parlak ürünlerin yoğun yaya trafiği olan alanlarda kullanımı önerilmez.

100x300 cm, 120x360 cm and 160x320 cm are rectified sizes.
100x300 cm, 120x360 cm ve 160x320 cm ebatlar karelenmiş ebatlardır.

Please check pages between 146-155 for dimension detail chart.

Ebat tablosu için 146-151 sayfaları arasına bakınız.

The use of polished products in areas with heavy pedestrian traffic is not recommended.
Parlak ürünlerin yoğun yaya trafiği olan alanlarda kullanımı önerilmez.

Marble | Exclusive

Mermer | Özel



ALAMEDA

	mm	Matte	Soft Matte	Polished	Satin
100x300 cm	3	•			
	5				
120x360 cm	3	•			
	5				
160x320 cm 162x323 cm	6				
	12				
	20				



Interior & Design



Facade



Kitchen



Furniture



Bathroom



Indoor



Outdoor



Commercial



Gleaming



Wall



Floor



Moderate Variation



Face sayısını belirtmektedir.

100x300 cm, 120x360 cm and 160x320 cm are rectified sizes.
100x300 cm, 120x360 cm ve 160x320 cm ebatlar karelenmiş ebatlardır.

Please check pages between 146-155 for dimension detail chart.

Ebat tablosu için 146-151 sayfaları arasına bakınız.

The use of polished products in areas with heavy pedestrian traffic is not recommended.
Parlak ürünlerin yoğun yaya trafiği olan alanlarda kullanımı önerilmez.

Marble | Timeless

Mermer | Zamansız

new
yeni



FIORI DI BOSCO

	mm	Matte	Soft Matte	Polished	Satin	Face
100x300 cm	3					
	5					
120x360 cm	3					
	5					
160x320 cm 162x323 cm	6		•	•		3F
	12					
	20					

FLOW
TECH



Interior & Design



Facade



Kitchen



Furniture



Bathroom



Indoor



Outdoor



Commercial



Gleaming



Wall



Floor



Moderate Variation



Face sayısını belirtmektedir.

100x300 cm, 120x360 cm and 160x320 cm are rectified sizes.
100x300 cm, 120x360 cm ve 160x320 cm ebatlar karelenmiş ebatlardır.

Please check pages between 146-155 for dimension detail chart.

Ebat tablosu için 146-151 sayfaları arasına bakınız.

The use of polished products in areas with heavy pedestrian traffic is not recommended.
Parlak ürünlerin yoğun yaya trafiği olan alanlarda kullanımı önerilmez.

Marble | Timeless

Mermer | Zamansız

new
yeni



CRYSTALLUS

	mm	Matte	Soft Matte	Polished	Satin	Face
100x300 cm	3 5					
120x360 cm	3 5					
160x320 cm 162x323 cm	6 12 20			•		3F

GLOW
TECH

new
yeni



DENISE

	mm	Matte	Soft Matte	Polished	Satin	Face
100x300 cm	3 5					
120x360 cm	3 5					
160x320 cm 162x323 cm	6 12 20		•	•		3F

GLOW
TECH



PULPIS

	mm	Matte	Soft Matte	Polished	Satin
100x300 cm	3 5	•			
120x360 cm	3 5	•			
160x320 cm 162x323 cm	6 12 20				



TRANSLUCENT ONYX

	mm	Matte	Soft Matte	Polished	Satin
100x300 cm	3 5	•			
120x360 cm	3 5				
160x320 cm 162x323 cm	6 12 20				



Interior & Design



Facade



Kitchen



Furniture



Bathroom



Indoor



Outdoor



Commercial



Gleaming



Wall



Floor



Moderate Variation



Face sayısını belirtmektedir.



Interior & Design



Facade



Kitchen



Furniture



Bathroom



Indoor



Outdoor



Commercial



Gleaming



Wall



Floor



Moderate Variation



Face sayısını belirtmektedir.

100x300 cm, 120x360 cm and 160x320 cm are rectified sizes.
100x300 cm, 120x360 cm ve 160x320 cm ebatlar karelenmiş ebatlardır.

Please check pages between 146-155 for dimension detail chart.

Ebat tablosu için 146-151 sayfaları arasına bakınız.

The use of polished products in areas with heavy pedestrian traffic is not recommended.
Parlak ürünlerin yoğun yaya trafiği olan alanlarda kullanımı önerilmez.

100x300 cm, 120x360 cm and 160x320 cm are rectified sizes.
100x300 cm, 120x360 cm ve 160x320 cm ebatlar karelenmiş ebatlardır.

Please check pages between 146-155 for dimension detail chart.

The use of polished products in areas with heavy pedestrian traffic is not recommended.
Parlak ürünlerin yoğun yaya trafiği olan alanlarda kullanımı önerilmez.

Ebat tablosu için 146-151 sayfaları arasına bakınız.

STONE LOOK
DOĞALTAŞ GÖRÜNÜM



Stone Look

Doğaltaş Görünüm



UPTOWN DARK



RAPOLANO IVORY

Stone Look

Doğaltaş Görünüm



Stone

Doğaltaş

new
yeni

**EARTH COLLECTION
RAPOLANO IVORY**
EARTH KOLEKSİYONU
RAPOLANO IVORY

mm	Matte	Soft Matte	Polished	Satin	Face
100x300 cm	3				
	5				
120x360 cm	3				
	5				
160x320 cm	6	•			3F
162x323 cm	12	•			
	20				

FORM **DECO**
TECH TECH



**EARTH COLLECTION
RAPOLANO SILVER**
EARTH KOLEKSİYONU
RAPOLANO SILVER

mm	Matte	Soft Matte	Polished	Satin	Rock Surface
100x300 cm	3				
	5				
120x360 cm	3				
	5				
160x320 cm	6	•			3F
162x323 cm	12	•			
	20				

FORM **DECO**
TECH TECH



Interior & Design



Facade



Kitchen



Furniture



Bathroom



Indoor



Outdoor



Commercial



Gleaming



Wall



Floor



Moderate Variation



Face sayısını belirtmektedir.

100x300 cm, 120x360 cm and 160x320 cm are rectified sizes.
100x300 cm, 120x360 cm ve 160x320 cm ebatlar karelenmiş ebatlardır.

Please check pages between 146-155 for dimension detail chart.

Ebat tablosu için 146-151 sayfaları arasına bakınız.

The use of polished products in areas with heavy pedestrian traffic is not recommended.
Parlak ürünlerin yoğun yaya trafiği olan alanlarda kullanımı önerilmez.

new
yeni

**EARTH COLLECTION
TRAVERTINE IVORY**
EARTH KOLEKSİYONU
TRAVERTINE IVORY

mm	Matte	Soft Matte	Polished	Satin	Face
100x300 cm	3				
	5				
120x360 cm	3				
	5				
160x320 cm	6	•			3F
162x323 cm	12	•			
	20				

FORM
TECH

new
yeni

**EARTH COLLECTION
TRAVERTINE SILVER**
EARTH KOLEKSİYONU
TRAVERTINE SILVER

mm	Matte	Soft Matte	Polished	Satin	Face
100x300 cm	3				
	5				
120x360 cm	3				
	5				
160x320 cm	6	•			3F
162x323 cm	12	•			
	20				

FORM
TECH



Interior & Design



Facade



Kitchen



Furniture



Bathroom



Indoor



Outdoor



Commercial



Gleaming



Wall



Floor



Moderate Variation



Face sayısını belirtmektedir.

100x300 cm, 120x360 cm and 160x320 cm are rectified sizes.
100x300 cm, 120x360 cm ve 160x320 cm ebatlar karelenmiş ebatlardır.

Please check pages between 146-155 for dimension detail chart.

Ebat tablosu için 146-151 sayfaları arasına bakınız.

The use of polished products in areas with heavy pedestrian traffic is not recommended.
Parlak ürünlerin yoğun yaya trafiği olan alanlarda kullanımı önerilmez.

Stone

Doğaltaş

new
yeniCALCARIO COLLECTION
GREIGEnew
yeniCALCARIO COLLECTION
LINE GREIGEnew
yeniCALCARIO COLLECTION
LIGHT GREIGEnew
yeniCALCARIO COLLECTION
LIGHT LINE GREIGEOCEAN WHITE
OCEAN BEYAZOCEAN BLACK
OCEAN SİYAH

mm	Matte	Soft Matte	Polished	Satin	Rock Surface	Face
100x300 cm	3					
	5					
120x360 cm	3					
	5					
160x320 cm	6	•				2F
162x323 cm	12	•			•	
	20					

mm	Matte	Soft Matte	Polished	Satin	Rock Surface	Face
100x300 cm	3					
	5					
120x360 cm	3					
	5					
160x320 cm	6	•				2F
162x323 cm	12					
	20					

mm	Matte	Soft Matte	Polished	Satin	Rock Surface	Face
100x300 cm	3					
	5					
120x360 cm	3					
	5					
160x320 cm	6	•				2F
162x323 cm	12	•			•	
	20					

mm	Matte	Soft Matte	Polished	Satin	Face
100x300 cm	3				
	5				
120x360 cm	3				
	5				
160x320 cm	6	•			2F
162x323 cm	12				
	20				

mm	Matte	Soft Matte	Polished	Satin	Face
100x300 cm	3	•			3F
	5	•			
120x360 cm	3				
	5				
160x320 cm	6				
162x323 cm	12				
	20				

mm	Matte	Soft Matte	Polished	Satin	Face
100x300 cm	3	•			3F
	5	•			
120x360 cm	3				
	5				
160x320 cm	6				
162x323 cm	12				
	20				

BODY
TECH FORM
TECHBODY
TECH FORM
TECH DECO
TECHBODY
TECH FORM
TECHBODY
TECH FORM
TECH DECO
TECH

Interior & Design



Facade



Kitchen



Furniture



Bathroom



Indoor



Outdoor



Commercial



Gleaming



Wall



Floor



Moderate Variation



Face sayısı belirtilmektedir.



Interior & Design



Facade



Kitchen



Furniture



Bathroom



Indoor



Outdoor



Commercial



Gleaming



Wall



Floor



Moderate Variation



Face sayısı belirtilmektedir.

100x300 cm, 120x360 cm and 160x320 cm are rectified sizes.
100x300 cm, 120x360 cm ve 160x320 cm ebatlar karelenmiş ebatlardır.

Please check pages between 146-155 for dimension detail chart.

Ebat tablosu için 146-151 sayfaları arasına bakınız.

The use of polished products in areas with heavy pedestrian traffic is not recommended.
Parlak ürünlerin yoğun yaya trafiği olan alanlarda kullanımı önerilmez.

100x300 cm, 120x360 cm and 160x320 cm are rectified sizes.
100x300 cm, 120x360 cm ve 160x320 cm ebatlar karelenmiş ebatlardır.

Please check pages between 146-155 for dimension detail chart.

The use of polished products in areas with heavy pedestrian traffic is not recommended.
Parlak ürünlerin yoğun yaya trafiği olan alanlarda kullanımı önerilmez.

Ebat tablosu için 146-151 sayfaları arasına bakınız.

Stone

Doğaltaş



NATURAL STONE
LECCESE LIGHT SAND

	mm	Matte	Soft Matte	Polished	Satin
100x300 cm	3	•			
	5	•			
120x360 cm	3				
	5				
160x320 cm 162x323 cm	6				
	12				
	20				



NATURAL STONE
LECCESE DARK SAND

	mm	Matte	Soft Matte	Polished	Satin
100x300 cm	3	•			
	5	•			
120x360 cm	3	•			
	5	•			
160x320 cm 162x323 cm	6				
	12				
	20				



NATURAL STONE
LECCESE GREY

	mm	Matte	Soft Matte	Polished	Satin
100x300 cm	3	•			
	5	•			
120x360 cm	3				
	5				
160x320 cm 162x323 cm	6				
	12				
	20				



NATURAL STONE PIETRA BLUE
NATURAL STONE PIETRA MAVİ

	mm	Matte	Soft Matte	Polished	Satin	Rock Surface
100x300 cm	3	•				
	5	•				
120x360 cm	3	•				
	5	•				
160x320 cm 162x323 cm	6					
	12					
	20					



NATURAL STONE PIETRA GREY
NATURAL STONE PIETRA GRİ

	mm	Matte	Soft Matte	Polished	Satin	Rock Surface
100x300 cm	3	•				
	5	•				
120x360 cm	3					
	5					
160x320 cm 162x323 cm	6					
	12					
	20					



Interior & Design



Facade



Kitchen



Furniture



Bathroom



Indoor



Outdoor



Commercial



Wall



Floor



Slight Variation

100x300 cm, 120x360 cm and 160x320 cm are rectified sizes.
100x300 cm, 120x360 cm ve 160x320 cm ebatlar karelenmiş ebatlardır.

The use of polished products in areas with heavy pedestrian traffic is not recommended.
Parlak ürünlerin yoğun yaya trafiği olan alanlarda kullanımı önerilmez.

Please check pages between 146-155 for dimension detail chart.

Ebat tablosu için 146-151 sayfaları arasına bakınız.



Interior & Design



Facade



Kitchen



Furniture



Bathroom



Indoor



Outdoor



Commercial



Wall



Floor



Slight Variation

100x300 cm, 120x360 cm and 160x320 cm are rectified sizes.
100x300 cm, 120x360 cm ve 160x320 cm ebatlar karelenmiş ebatlardır.

The use of polished products in areas with heavy pedestrian traffic is not recommended.
Parlak ürünlerin yoğun yaya trafiği olan alanlarda kullanımı önerilmez.

Please check pages between 146-155 for dimension detail chart.

Ebat tablosu için 146-151 sayfaları arasına bakınız.

Stone

Doğaltaş



C-STONE WHITE
C-STONE BEYAZ



C-STONE BEIGE
C-STONE BEJ



C-STONE GREY
C-STONE GRİ



C-STONE BROWN
C-STONE KAHVE



C-STONE ANTHRACITE
C-STONE ANTRASİT

	mm	Matte	Soft Matte	Polished	Satin
100x300 cm	3	•			
	5	•			
120x360 cm	3	•			
	5	•			
160x320 cm	6				
	12				
162x323 cm	20				

	mm	Matte	Soft Matte	Polished	Satin
100x300 cm	3	•			
	5	•			
120x360 cm	3	•			
	5	•			
160x320 cm	6				
	12				
162x323 cm	20				

	mm	Matte	Soft Matte	Polished	Satin
100x300 cm	3	•			
	5	•			
120x360 cm	3	•			
	5	•			
160x320 cm	6				
	12				
162x323 cm	20				

	mm	Matte	Soft Matte	Polished	Satin
100x300 cm	3	•			
	5	•			
120x360 cm	3	•			
	5	•			
160x320 cm	6				
	12				
162x323 cm	20				

	mm	Matte	Soft Matte	Polished	Satin
100x300 cm	3	•			
	5	•			
120x360 cm	3	•			
	5	•			
160x320 cm	6				
	12				
162x323 cm	20				



Interior & Design



Facade



Kitchen



Furniture



Bathroom



Indoor



Outdoor



Commercial



Wall



Floor



Slight Variation

100x300 cm, 120x360 cm and 160x320 cm are rectified sizes.
100x300 cm, 120x360 cm ve 160x320 cm ebatlar karelenmiş ebatlardır.

The use of polished products in areas with heavy pedestrian traffic is not recommended.
Parlak ürünlerin yoğun yaya trafiği olan alanlarda kullanımı önerilmez.

Please check pages between 146-155 for dimension detail chart.

Ebat tablosu için 146-151 sayfaları arasına bakınız.



Interior & Design



Facade



Kitchen



Furniture



Bathroom



Indoor



Outdoor



Commercial



Wall



Floor



Slight Variation

100x300 cm, 120x360 cm and 160x320 cm are rectified sizes.
100x300 cm, 120x360 cm ve 160x320 cm ebatlar karelenmiş ebatlardır.

The use of polished products in areas with heavy pedestrian traffic is not recommended.
Parlak ürünlerin yoğun yaya trafiği olan alanlarda kullanımı önerilmez.

Please check pages between 146-155 for dimension detail chart.

Ebat tablosu için 146-151 sayfaları arasına bakınız.

Stone

Doğaltaş



PIETRA BASALTINA

	mm	Matte	Soft Matte	Polished	Satin	Rock Surface
100x300 cm	3	•				
	5					
120x360 cm	3					
	5					
160x320 cm	6					
	12		•			
162x323 cm	12					•
	20					

FORM
TECH

PIETRA CHATILLONN

	mm	Matte	Soft Matte	Polished	Satin
100x300 cm	3	•			
	5	•			
120x360 cm	3				
	5				
160x320 cm	6				
	12				
162x323 cm	12				
	20				

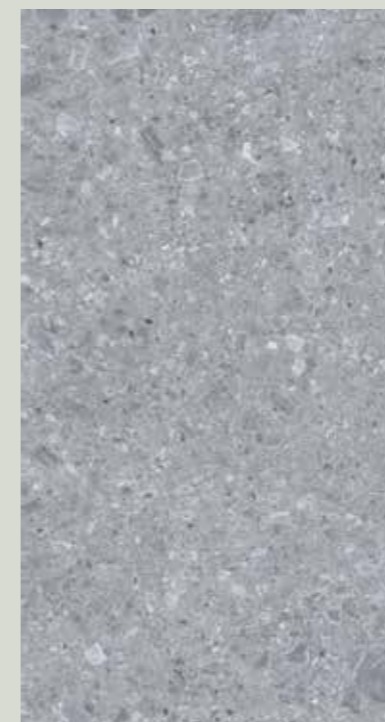
FORM
TECHPIETRA DI GRE GREY
PIETRA DI GRE GRİ

	mm	Matte	Soft Matte	Polished	Satin	Face
100x300 cm	3	•				
	5					
120x360 cm	3	•				
	5					
160x320 cm	6		•			3F
	12		•			
162x323 cm	12		•			
	20		•			

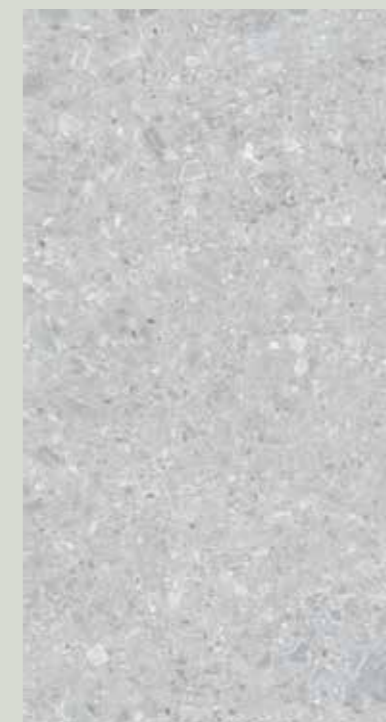
FORM
TECHPIETRA DI GRE BONE
PIETRA DI GRE KEMİK

	mm	Matte	Soft Matte	Polished	Satin	Face
100x300 cm	3	•				
	5					
120x360 cm	3	•				
	5					
160x320 cm	6		•			3F
	12		•			
162x323 cm	12		•			
	20		•			

FORM
TECH

Interior & Design



Facade



Kitchen



Furniture



Bathroom



Indoor



Outdoor



Commercial



Gleaming



Wall



Floor



Moderate Variation



Face sayısı belirtilmektedir.

100x300 cm, 120x360 cm and 160x320 cm are rectified sizes.
100x300 cm, 120x360 cm ve 160x320 cm ebatlar karelenmiş ebatlardır.

The use of polished products in areas with heavy pedestrian traffic is not recommended.
Parlak ürünlerin yoğun yaya trafiği olan alanlarda kullanımı önerilmez.

Please check pages between 146-155 for dimension detail chart.

Ebat tablosu için 146-151 sayfaları arasına bakınız.



Interior & Design



Facade



Kitchen



Furniture



Bathroom



Indoor



Outdoor



Commercial



Gleaming



Wall



Floor



Moderate Variation



Face sayısı belirtilmektedir.

100x300 cm, 120x360 cm and 160x320 cm are rectified sizes.
100x300 cm, 120x360 cm ve 160x320 cm ebatlar karelenmiş ebatlardır.

The use of polished products in areas with heavy pedestrian traffic is not recommended.
Parlak ürünlerin yoğun yaya trafiği olan alanlarda kullanımı önerilmez.

Please check pages between 146-155 for dimension detail chart.

Ebat tablosu için 146-151 sayfaları arasına bakınız.

Stone

Doğaltaş



UPTOWN DARK
UPTOWN KOYU

	mm	Matte	Soft Matte	Polished	Satin
100x300 cm	3	•			
	5	•			
120x360 cm	3	•			
	5	•			
160x320 cm 162x323 cm	6				
	12				
	12				
	20				



UPTOWN LIGHT
UPTOWN AÇIK

	mm	Matte	Soft Matte	Polished	Satin
100x300 cm	3	•			
	5	•			
120x360 cm	3	•			
	5	•			
160x320 cm 162x323 cm	6				
	12				
	12				
	20				



TRAVERTINO

	mm	Matte	Soft Matte	Polished	Satin
100x300 cm	3				
	5				
120x360 cm	3	•			
	5				
160x320 cm 162x323 cm	6				
	12				
	12				
	20				



LIMESTONE

	mm	Matte	Soft Matte	Polished	Satin
100x300 cm	3	•			
	5	•			
120x360 cm	3	•			
	5	•			
160x320 cm 162x323 cm	6				
	12				
	12				
	20				



Interior & Design



Facade



Kitchen



Furniture



Bathroom



Indoor



Outdoor



Commercial



Structured



Wall



Floor



Slight Variation

100x300 cm, 120x360 cm and 160x320 cm are rectified sizes.
100x300 cm, 120x360 cm ve 160x320 cm ebatlar karelenmiş ebatlardır.

The use of polished products in areas with heavy pedestrian traffic is not recommended.
Parlak ürünlerin yoğun yaya trafiği olan alanlarda kullanımı önerilmez.

Please check pages between 146-155 for dimension detail chart.

Ebat tablosu için 146-151 sayfaları arasına bakınız.



Interior & Design



Facade



Kitchen



Furniture



Bathroom



Indoor



Outdoor



Commercial



Structured



Wall



Floor



Slight Variation

100x300 cm, 120x360 cm and 160x320 cm are rectified sizes.
100x300 cm, 120x360 cm ve 160x320 cm ebatlar karelenmiş ebatlardır.

The use of polished products in areas with heavy pedestrian traffic is not recommended.
Parlak ürünlerin yoğun yaya trafiği olan alanlarda kullanımı önerilmez.

Please check pages between 146-155 for dimension detail chart.

Ebat tablosu için 146-151 sayfaları arasına bakınız.

Stone

Doğaltaş

new
yeni

STONE GALLERY QUARTZ ASH

	mm	Matte	Soft Matte	Polished	Satin
100x300 cm	3 5	•			
120x360 cm	3 5				
160x320 cm 162x323 cm	6 12 20				



CITYSCAPE

	mm	Matte	Soft Matte	Polished	Satin
100x300 cm	3 5				
120x360 cm	3 5				
160x320 cm 162x323 cm	6 12 20		•		



BRERA CREME

	mm	Matte	Soft Matte	Polished	Satin
100x300 cm	3 5	•			
120x360 cm	3 5				
160x320 cm 162x323 cm	6 12 20				



MONOLITH

	mm	Matte	Soft Matte	Polished	Satin
100x300 cm	3 5	•			
120x360 cm	3 5				
160x320 cm 162x323 cm	6 12 20				



PIAMONTE

	mm	Matte	Soft Matte	Polished	Satin
100x300 cm	3 5	•			
120x360 cm	3 5				
160x320 cm 162x323 cm	6 12 20				

BODY TECH **FORM** TECH



Interior & Design



Facade



Kitchen



Furniture



Bathroom



Indoor



Outdoor



Commercial



Wall



Floor



Slight Variation

100x300 cm, 120x360 cm and 160x320 cm are rectified sizes.
100x300 cm, 120x360 cm ve 160x320 cm ebatlar karelenmiş ebatlardır.

The use of polished products in areas with heavy pedestrian traffic is not recommended.
Parlak ürünlerin yoğun yaya trafiği olan alanlarda kullanımı önerilmez.

Please check pages between 146-155 for dimension detail chart.

Ebat tablosu için 146-151 sayfaları arasına bakınız.



Interior & Design



Facade



Kitchen



Furniture



Bathroom



Indoor



Outdoor



Commercial



Wall



Floor



Slight Variation

100x300 cm, 120x360 cm and 160x320 cm are rectified sizes.
100x300 cm, 120x360 cm ve 160x320 cm ebatlar karelenmiş ebatlardır.

The use of polished products in areas with heavy pedestrian traffic is not recommended.
Parlak ürünlerin yoğun yaya trafiği olan alanlarda kullanımı önerilmez.

Please check pages between 146-155 for dimension detail chart.

Ebat tablosu için 146-151 sayfaları arasına bakınız.

CEMENT LOOK
ÇİMENTO GÖRÜNÜM



LUXURY CEMENT GREY
LUXURY CEMENT GRİ

Cement Look

Çimento Görünüm



HIGHWAY BONE
HIGHWAY KEMİK

Cement

Çimento

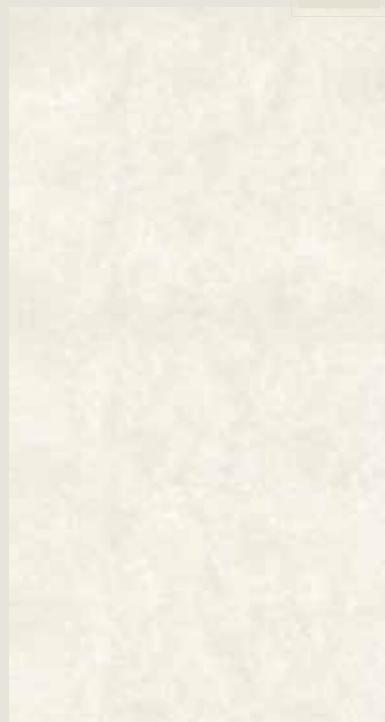
new
yeniLUXURY CEMENT WHITE
LUXURY CEMENT BEYAZLUXURY CEMENT BEIGE
LUXURY CEMENT BEJLUXURY CEMENT GREY
LUXURY CEMENT GRİLUXURY CEMENT CEMENTO
LUXURY CEMENT ÇİMENTO

LUXURY CEMENT TAUPE

LUXURY CEMENT MINK
LUXURY CEMENT VİZON

	mm	Matte	Soft Matte	Polished	Satin
100x300 cm	3	•			
	5	•			
120x360 cm	3	•			
	5	•			
160x320 cm 162x323 cm	6		•		
	12		•		
	20		•		

	mm	Matte	Soft Matte	Polished	Satin
100x300 cm	3	•			
	5	•			
120x360 cm	3	•			
	5	•			
160x320 cm 162x323 cm	6		•		
	12		•		
	20		•		

	mm	Matte	Soft Matte	Polished	Satin
100x300 cm	3	•			
	5	•			
120x360 cm	3	•			
	5	•			
160x320 cm 162x323 cm	6		•		
	12		•		
	20		•		

	mm	Matte	Soft Matte	Polished	Satin
100x300 cm	3	•			
	5	•			
120x360 cm	3	•			
	5	•			
160x320 cm 162x323 cm	6		•		
	12		•		
	20		•		

	mm	Matte	Soft Matte	Polished	Satin
100x300 cm	3	•			
	5	•			
120x360 cm	3	•			
	5	•			
160x320 cm 162x323 cm	6		•		
	12		•		
	20		•		

	mm	Matte	Soft Matte	Polished	Satin
100x300 cm	3	•			
	5	•			
120x360 cm	3	•			
	5	•			
160x320 cm 162x323 cm	6		•		
	12		•		
	20		•		



Interior & Design



Facade



Kitchen



Furniture



Bathroom



Indoor



Outdoor



Commercial



Wall



Floor



Uniform Appearance

100x300 cm, 120x360 cm and 160x320 cm are rectified sizes.
100x300 cm, 120x360 cm ve 160x320 cm ebatlar karelenmiş ebatlardır.

Please check pages between 146-155 for dimension detail chart.

Ebat tablosu için 146-151 sayfaları arasına bakınız.

The use of polished products in areas with heavy pedestrian traffic is not recommended.
Parlak ürünlerin yoğun yaya trafiği olan alanlarda kullanımı önerilmez.



Interior & Design



Facade



Kitchen



Furniture



Bathroom



Indoor



Outdoor



Commercial



Wall



Floor



Uniform Appearance

100x300 cm, 120x360 cm and 160x320 cm are rectified sizes.
100x300 cm, 120x360 cm ve 160x320 cm ebatlar karelenmiş ebatlardır.

Please check pages between 146-155 for dimension detail chart.

Ebat tablosu için 146-151 sayfaları arasına bakınız.

The use of polished products in areas with heavy pedestrian traffic is not recommended.
Parlak ürünlerin yoğun yaya trafiği olan alanlarda kullanımı önerilmez.

Cement

Çimento



LUXURY CEMENT ANTHRACITE
LUXURY CEMENT ANTRASİT

	mm	Matte	Soft Matte	Polished	Satin
100x300 cm	3	•			
	5	•			
120x360 cm	3	•			
	5	•			
160x320 cm 162x323 cm	6		•		
	12				
	20				



LUXURY CEMENT ANTHI

	mm	Matte	Soft Matte	Polished	Satin
100x300 cm	3	•			
	5	•			
120x360 cm	3	•			
	5	•			
160x320 cm 162x323 cm	6		•		
	12				
	20				

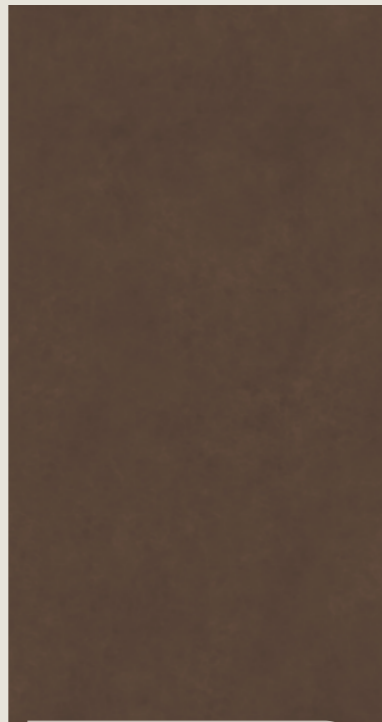

LUXURY CEMENT BROWN
LUXURY CEMENT KAHVE

	mm	Matte	Soft Matte	Polished	Satin
100x300 cm	3	•			
	5	•			
120x360 cm	3	•			
	5	•			
160x320 cm 162x323 cm	6		•		
	12				
	20				

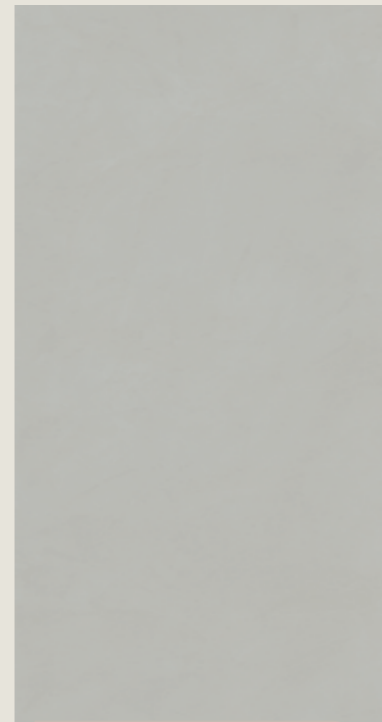

HUED OFF WHITE

	mm	Matte	Soft Matte	Polished	Satin
100x300 cm	3	•			
	5	•			
120x360 cm	3	•			
	5	•			
160x320 cm 162x323 cm	6		•		
	12				
	20				

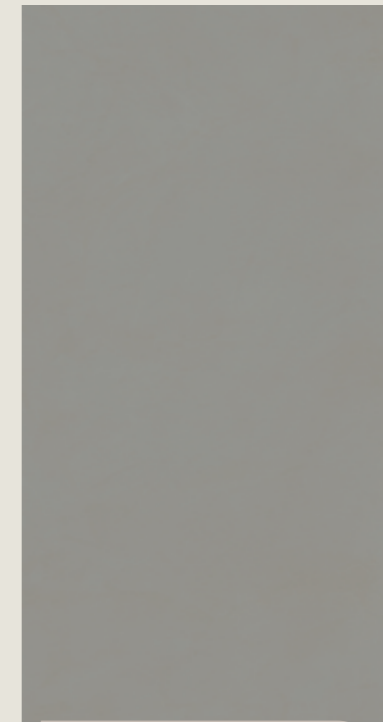

HUED GREY
HUED GRİ

	mm	Matte	Soft Matte	Polished	Satin
100x300 cm	3	•			
	5	•			
120x360 cm	3	•			
	5	•			
160x320 cm 162x323 cm	6		•		
	12				
	20				



HUED DARK GREY
HUED KOYU GRİ

	mm	Matte	Soft Matte	Polished	Satin
100x300 cm	3	•			
	5	•			
120x360 cm	3	•			
	5	•			
160x320 cm 162x323 cm	6		•		
	12				
	20				



Interior & Design



Facade



Kitchen



Furniture



Bathroom



Indoor



Outdoor



Commercial



Wall



Floor



Uniform Appearance

100x300 cm, 120x360 cm and 160x320 cm are rectified sizes.
100x300 cm, 120x360 cm ve 160x320 cm ebatlar karelenmiş ebatlardır.

The use of polished products in areas with heavy pedestrian traffic is not recommended.
Parlak ürünlerin yoğun yaya trafiği olan alanlarda kullanımı önerilmez.

Please check pages between 146-155 for dimension detail chart.

Ebat tablosu için 146-151 sayfaları arasına bakınız.



Interior & Design



Facade



Kitchen



Furniture



Bathroom



Indoor



Outdoor



Commercial



Wall



Floor



Uniform Appearance

100x300 cm, 120x360 cm and 160x320 cm are rectified sizes.
100x300 cm, 120x360 cm ve 160x320 cm ebatlar karelenmiş ebatlardır.

The use of polished products in areas with heavy pedestrian traffic is not recommended.
Parlak ürünlerin yoğun yaya trafiği olan alanlarda kullanımı önerilmez.

Please check pages between 146-155 for dimension detail chart.

Ebat tablosu için 146-151 sayfaları arasına bakınız.

Cement

Çimento

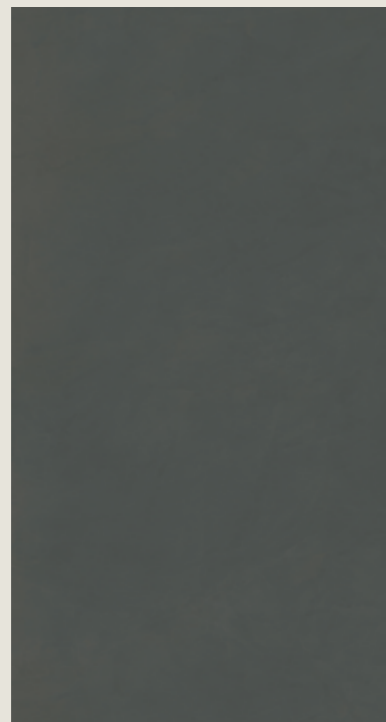

HUED ANTHRACITE
HUED ANTRASİT

	mm	Matte	Soft Matte	Polished	Satin
100x300 cm	3	•			
	5	•			
120x360 cm	3	•			
	5	•			
160x320 cm 162x323 cm	6				
	12				
	12				
	20				



HIGHWAY BONE
HIGHWAY KEMİK

	mm	Matte	Soft Matte	Polished	Satin
100x300 cm	3				
	5				
120x360 cm	3	•			
	5				
160x320 cm 162x323 cm	6				
	12		•		
	12				
	20				



ARCHE WHITE
ARCHE BEYAZ

	mm	Matte	Soft Matte	Polished	Satin
100x300 cm	3	•			
	5	•			
120x360 cm	3				
	5				
160x320 cm 162x323 cm	6				
	12				
	12				
	20				



ARCHE GREY
ARCHE GRİ

	mm	Matte	Soft Matte	Polished	Satin
100x300 cm	3	•			
	5	•			
120x360 cm	3				
	5				
160x320 cm 162x323 cm	6				
	12				
	12				
	20				



Interior & Design



Facade



Kitchen



Furniture



Bathroom



Indoor



Outdoor



Commercial



Wall



Floor



Slight Variation

100x300 cm, 120x360 cm and 160x320 cm are rectified sizes.
100x300 cm, 120x360 cm ve 160x320 cm ebatlar karelenmiş ebatlardır.

The use of polished products in areas with heavy pedestrian traffic is not recommended.
Parlak ürünlerin yoğun yaya trafiği olan alanlarda kullanımı önerilmez.

Please check pages between 146-155 for dimension detail chart.

Ebat tablosu için 146-151 sayfaları arasına bakınız.



Interior & Design



Facade



Kitchen



Furniture



Bathroom



Indoor



Outdoor



Commercial



Wall



Floor



Slight Variation

100x300 cm, 120x360 cm and 160x320 cm are rectified sizes.
100x300 cm, 120x360 cm ve 160x320 cm ebatlar karelenmiş ebatlardır.

The use of polished products in areas with heavy pedestrian traffic is not recommended.
Parlak ürünlerin yoğun yaya trafiği olan alanlarda kullanımı önerilmez.

Please check pages between 146-155 for dimension detail chart.

Ebat tablosu için 146-151 sayfaları arasına bakınız.

Cement

Çimento



FACTORY BLACK
FACTORY SİYAH

	mm	Matte	Soft Matte	Polished	Satin
100x300 cm	3	•			
	5				
120x360 cm	3				
	5				
160x320 cm 162x323 cm	6				
	12				
	20				



FACTORY GREIGE

	mm	Matte	Soft Matte	Polished	Satin
100x300 cm	3	•			
	5				
120x360 cm	3				
	5				
160x320 cm 162x323 cm	6				
	12				
	20				



FACTORY SILVER
FACTORY GÜMÜŞ

	mm	Matte	Soft Matte	Polished	Satin
100x300 cm	3	•			
	5				
120x360 cm	3				
	5				
160x320 cm 162x323 cm	6				
	12				
	20				



Interior & Design



Facade



Kitchen



Furniture



Bathroom



Indoor



Outdoor



Commercial



Wall



Floor



Slight Variation

100x300 cm, 120x360 cm and 160x320 cm are rectified sizes.
100x300 cm, 120x360 cm ve 160x320 cm ebatlar karelenmiş ebatlardır.

The use of polished products in areas with heavy pedestrian traffic is not recommended.
Parlak ürünlerin yoğun yaya trafiği olan alanlarda kullanımı önerilmez.

Please check pages between 146-155 for dimension detail chart.

Ebat tablosu için 146-151 sayfaları arasına bakınız.



Interior & Design



Facade



Kitchen



Furniture



Bathroom



Indoor



Outdoor



Commercial



Wall



Floor



Slight Variation

100x300 cm, 120x360 cm and 160x320 cm are rectified sizes.
100x300 cm, 120x360 cm ve 160x320 cm ebatlar karelenmiş ebatlardır.

The use of polished products in areas with heavy pedestrian traffic is not recommended.
Parlak ürünlerin yoğun yaya trafiği olan alanlarda kullanımı önerilmez.

Please check pages between 146-155 for dimension detail chart.

Ebat tablosu için 146-151 sayfaları arasına bakınız.

METAL LOOK
METAL GÖRÜNÜM



Metallic Look

Metalik Görünüm



METALLIC ANTHRACITE
METALİK ANTRASİT

Metallic

Metalik



METALLIC ANTHRACITE
METALİK ANTRASİT

	mm	Matte	Soft Matte	Polished	Satin
100x300 cm	3 5	• •			
120x360 cm	3 5				
160x320 cm 162x323 cm	6 12 20		•		



METALLIC CORAL
METALİK KIZIL

	mm	Matte	Soft Matte	Polished	Satin
100x300 cm	3 5	• •			
120x360 cm	3 5				
160x320 cm 162x323 cm	6 12 20				



FERRO

	mm	Matte	Soft Matte	Polished	Satin	Face
100x300 cm	3 5	• •				2F
120x360 cm	3 5	• •				
160x320 cm 162x323 cm	6 12 20					



STEEL

	mm	Matte	Soft Matte	Polished	Satin	Face
100x300 cm	3 5	• •				2F
120x360 cm	3 5	• •				
160x320 cm 162x323 cm	6 12 20					



LEDER BROWN
LEDER KAHVE

	mm	Matte	Soft Matte	Polished	Satin
100x300 cm	3 5	•			
120x360 cm	3 5				
160x320 cm 162x323 cm	6 12 20				



Interior & Design Facade Kitchen Furniture Bathroom Indoor Outdoor Commercial Wall Floor Slight Variation

100x300 cm, 120x360 cm and 160x320 cm are rectified sizes.
100x300 cm, 120x360 cm ve 160x320 cm ebatlar karelenmiş ebatlardır.

Please check pages between 146-151 for dimension detail chart.

Ebat tablosu için 146-151 sayfaları arasına bakınız.

The use of polished products in areas with heavy pedestrian traffic is not recommended.
Parlak ürünlerin yoğun yaya trafiği olan alanlarda kullanımı önerilmez.



Interior & Design Facade Kitchen Furniture Bathroom Indoor Outdoor Commercial Gleaming Wall Floor Moderate Variation Face sayısını belirtmektedir.

100x300 cm, 120x360 cm and 160x320 cm are rectified sizes.
100x300 cm, 120x360 cm ve 160x320 cm ebatlar karelenmiş ebatlardır.

Please check pages between 146-151 for dimension detail chart.

Ebat tablosu için 146-151 sayfaları arasına bakınız.

The use of polished products in areas with heavy pedestrian traffic is not recommended.
Parlak ürünlerin yoğun yaya trafiği olan alanlarda kullanımı önerilmez.

Metallic

Metalik

new
yeni

RUSTONE

	mm	Matte	Soft Matte	Polished	Satin	Face
100x300 cm	3 5					
120x360 cm	3 5					
160x320 cm 162x323 cm	6 12 20		•			3F

new
yeni

CORTEN

	mm	Matte	Soft Matte	Polished	Satin	Face
100x300 cm	3 5					
120x360 cm	3 5					
160x320 cm 162x323 cm	6 12 20		•			2F



Interior & Design



Facade



Kitchen



Furniture



Bathroom



Indoor



Outdoor



Commercial



Gleaming



Wall



Floor



Moderate Variation



Face sayısı belirtilmektedir.

100x300 cm, 120x360 cm and 160x320 cm are rectified sizes.
100x300 cm, 120x360 cm ve 160x320 cm ebatlar karelenmiş ebatlardır.

The use of polished products in areas with heavy pedestrian traffic is not recommended.
Parlak ürünlerin yoğun yaya trafiği olan alanlarda kullanımı önerilmez.

Please check pages between 146-151 for dimension detail chart.

Ebat tablosu için 146-151 sayfaları arasına bakınız.



ARTWALL

ARTWALL



Floral

Floral



new
yeni



BLUE BLOSSOMS

	mm	Matte	Soft Matte	Polished	Satin
100x300 cm	3 5				
120x360 cm	3 5				
160x320 cm	6		•		
162x323 cm	12 20				

DECO
TECH



Interior & Design



Facade



Kitchen



Furniture



Bathroom



Indoor



Outdoor



Commercial



Wall



Floor



Uniform Appearance

100x300 cm, 120x360 cm and 160x320 cm are rectified sizes.
100x300 cm, 120x360 cm ve 160x320 cm ebatlar karelenmiş ebatlardır.

The use of polished products in areas with heavy pedestrian traffic is not recommended.
Parlak ürünlerin yoğun yaya trafiği olan alanlarda kullanımı önerilmez.

Please check pages between 146-155 for dimension detail chart.

Ebat tablosu için 146-151 sayfaları arasına bakınız.

Floral

Floral



new
yeni



JASMINE

	mm	Matte	Soft Matte	Polished	Satin
100x300 cm	3 5				
120x360 cm	3 5				
160x320 cm	6		•		
162x323 cm	12 20				

DECO
TECH



Interior & Design



Facade



Kitchen



Furniture



Bathroom



Indoor



Outdoor



Commercial



Wall



Floor



Uniform Appearance

100x300 cm, 120x360 cm and 160x320 cm are rectified sizes.
100x300 cm, 120x360 cm ve 160x320 cm ebatlar karelenmiş ebatlardır.

The use of polished products in areas with heavy pedestrian traffic is not recommended.
Parlak ürünlerin yoğun yaya trafiği olan alanlarda kullanımı önerilmez.

Please check pages between 146-155 for dimension detail chart.

Ebat tablosu için 146-151 sayfaları arasına bakınız.

Geometric

Geometrik



new
yeni



LACE

	mm	Matte	Soft Matte	Polished	Satin
100x300 cm	3				
	5				
120x360 cm	3				
	5				
160x320 cm	6		•		
	12				
162x323 cm	20				

DECO
TECH



Interior & Design



Facade



Kitchen



Furniture



Bathroom



Indoor



Outdoor



Commercial



Wall



Floor



Uniform Appearance

100x300 cm, 120x360 cm and 160x320 cm are rectified sizes.
100x300 cm, 120x360 cm ve 160x320 cm ebatlar karelenmiş ebatlardır.

The use of polished products in areas with heavy pedestrian traffic is not recommended.
Parlak ürünlerin yoğun yaya trafiği olan alanlarda kullanımı önerilmez.

Please check pages between 146-155 for dimension detail chart.

Ebat tablosu için 146-151 sayfaları arasına bakınız.

Geometric

Geometrik



new
yeni



MOONDUST

	mm	Matte	Soft Matte	Polished	Satin
100x300 cm	3				
	5				
120x360 cm	3				
	5				
160x320 cm	6		•		3F
	12				
162x323 cm	20				

DECO
TECH



Interior & Design



Facade



Kitchen



Furniture



Bathroom



Indoor



Outdoor



Commercial



Wall



Floor



Moderate Variation

100x300 cm, 120x360 cm and 160x320 cm are rectified sizes.
100x300 cm, 120x360 cm ve 160x320 cm ebatlar karelenmiş ebatlardır.

The use of polished products in areas with heavy pedestrian traffic is not recommended.
Parlak ürünlerin yoğun yaya trafiği olan alanlarda kullanımı önerilmez.

Please check pages between 146-155 for dimension detail chart.

Ebat tablosu için 146-151 sayfaları arasına bakınız.

SOLID COLORS
DÜZ RENKLER



Solid Colors

Düz Renkler



Solid Colors

Düz Renkler

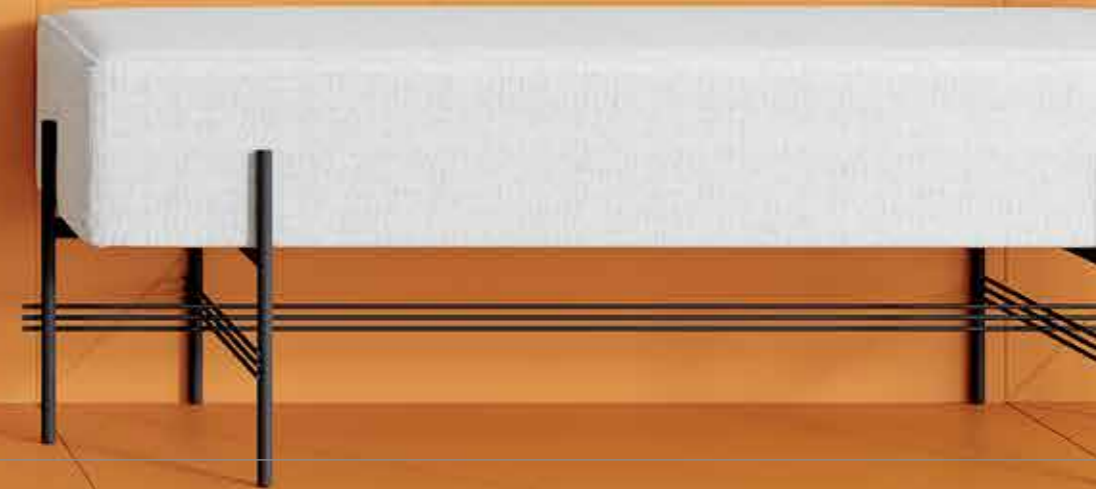

Solid Colors

Düz Renkler

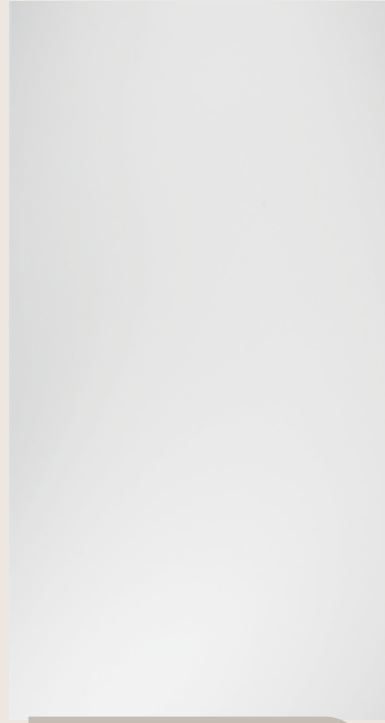

INNOVATION EXTRA WHITE
INNOVATION EXTRA BEYAZ

	mm	Matte	Soft Matte	Polished	Satin
100x300 cm	3	•			
	5	•			
120x360 cm	3	•			
	5	•			
160x320 cm 162x323 cm	6		•	•	
	12				
	20				

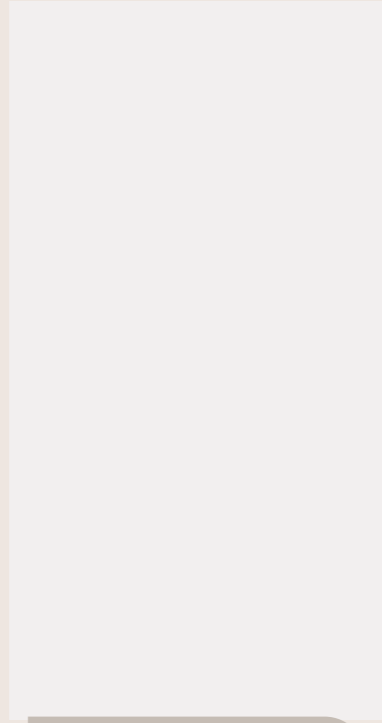

INNOVATION WHITE 2.0
INNOVATION BEYAZ 2.0

	mm	Matte	Soft Matte	Polished	Satin
100x300 cm	3	•			
	5	•			
120x360 cm	3	•			
	5	•			
160x320 cm 162x323 cm	6		•		
	12		•		
	20				

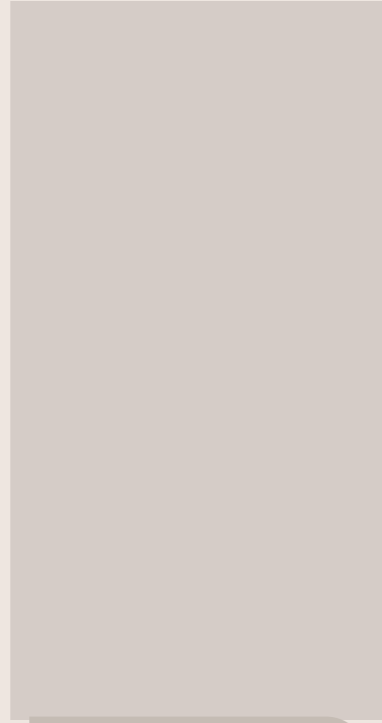

INNOVATION BEIGE
INNOVATION BEJ

	mm	Matte	Soft Matte	Polished	Satin
100x300 cm	3	•			
	5	•			
120x360 cm	3	•			
	5	•			
160x320 cm 162x323 cm	6				
	12				
	20				



INNOVATION BEIGE-GREY
INNOVATION BEJ-GRİ

	mm	Matte	Soft Matte	Polished	Satin
100x300 cm	3	•			
	5	•			
120x360 cm	3	•			
	5	•			
160x320 cm 162x323 cm	6				
	12				
	20				



INNOVATION CEMENT GREY
INNOVATION ÇİMENTO GRİ

	mm	Matte	Soft Matte	Polished	Satin
100x300 cm	3	•			
	5	•			
120x360 cm	3				
	5				
160x320 cm 162x323 cm	6				
	12				
	20				



INNOVATION PISTACHIO GREEN
INNOVATION FISTIK YEŞİLİ

	mm	Matte	Soft Matte	Polished	Satin
100x300 cm	3	•			
	5	•			
120x360 cm	3				
	5				
160x320 cm 162x323 cm	6				
	12				
	20				



Interior & Design



Facade



Kitchen



Furniture



Bathroom



Indoor



Outdoor



Commercial



Wall



Uniform Appearance



Interior & Design



Facade



Kitchen



Furniture



Bathroom



Indoor



Outdoor



Commercial



Wall



Uniform Appearance

100x300 cm, 120x360 cm and 160x320 cm are rectified sizes.
100x300 cm, 120x360 cm ve 160x320 cm ebatlar karelenmiş ebatlardır.

Please check pages between 146-155 for dimension detail chart.

Ebat tablosu için 146-151 sayfaları arasına bakınız.

The use of polished products in areas with heavy pedestrian traffic is not recommended.
Parlak ürünlerin yoğun yaya trafiği olan alanlarda kullanımı önerilmez.

100x300 cm, 120x360 cm and 160x320 cm are rectified sizes.
100x300 cm, 120x360 cm ve 160x320 cm ebatlar karelenmiş ebatlardır.

Please check pages between 146-155 for dimension detail chart.

Ebat tablosu için 146-151 sayfaları arasına bakınız.

The use of polished products in areas with heavy pedestrian traffic is not recommended.
Parlak ürünlerin yoğun yaya trafiği olan alanlarda kullanımı önerilmez.

Solid Colors

Düz Renkler

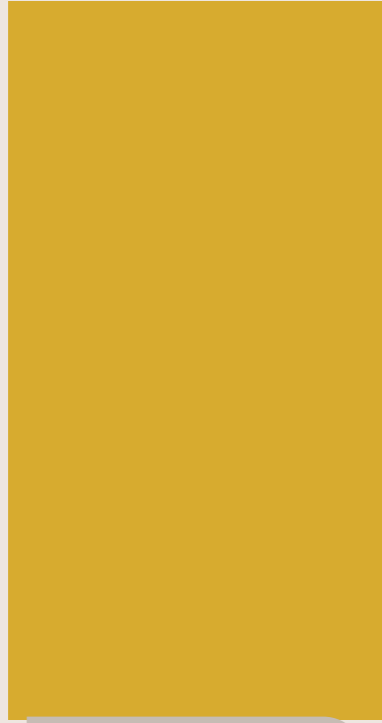

INNOVATION ORANGE
INNOVATION TURUNCU

	mm	Matte	Soft Matte	Polished	Satin
100x300 cm	3 5	•			
120x360 cm	3 5				
160x320 cm 162x323 cm	6 12 20				



INNOVATION CORAL
INNOVATION KIZIL

	mm	Matte	Soft Matte	Polished	Satin
100x300 cm	3 5	•			
120x360 cm	3 5				
160x320 cm 162x323 cm	6 12 20				



INNOVATION BLUE
INNOVATION MAVİ

	mm	Matte	Soft Matte	Polished	Satin
100x300 cm	3 5	•			
120x360 cm	3 5				
160x320 cm 162x323 cm	6 12 20				



Interior & Design



Facade



Kitchen



Furniture



Bathroom



Indoor



Outdoor



Commercial



Wall



Uniform Appearance



Interior & Design



Facade



Kitchen



Furniture



Bathroom



Indoor



Outdoor



Commercial



Wall



Uniform Appearance

100x300 cm, 120x360 cm and 160x320 cm are rectified sizes.
100x300 cm, 120x360 cm ve 160x320 cm ebatlar karelenmiş ebatlardır.

The use of polished products in areas with heavy pedestrian traffic is not recommended.
Parlak ürünlerin yoğun yaya trafiği olan alanlarda kullanımı önerilmez.

Please check pages between 146-155 for dimension detail chart.

Ebat tablosu için 146-151 sayfaları arasına bakınız.

100x300 cm, 120x360 cm and 160x320 cm are rectified sizes.
100x300 cm, 120x360 cm ve 160x320 cm ebatlar karelenmiş ebatlardır.

The use of polished products in areas with heavy pedestrian traffic is not recommended.
Parlak ürünlerin yoğun yaya trafiği olan alanlarda kullanımı önerilmez.

Please check pages between 146-155 for dimension detail chart.

Ebat tablosu için 146-151 sayfaları arasına bakınız.

Solid Colors

Düz Renkler



INNOVATION BROWN
INNOVATION KAHVERENGİ

	mm	Matte	Soft Matte	Polished	Satin
100x300 cm	3 5	•			
120x360 cm	3 5				
160x320 cm 162x323 cm	6 12 20				



INNOVATION DARK GREY
INNOVATION KOYU GRİ

	mm	Matte	Soft Matte	Polished	Satin
100x300 cm	3 5	•			
120x360 cm	3 5				
160x320 cm 162x323 cm	6 12 20				



INNOVATION BLACK
INNOVATION SİYAH

	mm	Matte	Soft Matte	Polished	Satin
100x300 cm	3 5	•			
120x360 cm	3 5	•			
160x320 cm 162x323 cm	6 12 20		•		

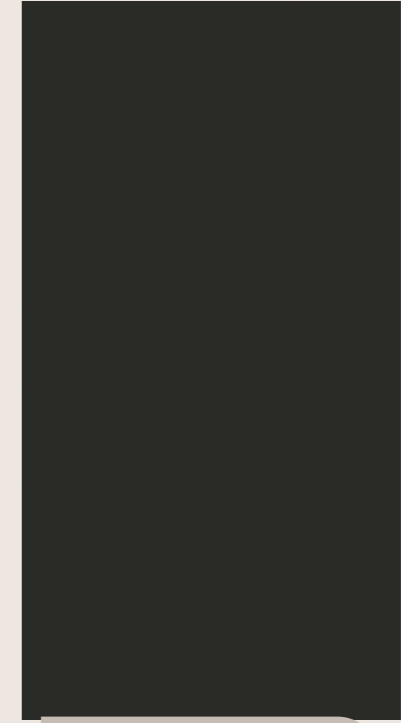

INNOVATION MEGA BLACK
INNOVATION MEGA SİYAH

	mm	Matte	Soft Matte	Polished	Satin
100x300 cm	3 5	•			
120x360 cm	3 5	•			
160x320 cm 162x323 cm	6 12 20		•	•	



Interior & Design



Facade



Kitchen



Furniture



Bathroom



Indoor



Outdoor



Commercial



Wall



Uniform Appearance



Interior & Design



Facade



Kitchen



Furniture



Bathroom



Indoor



Outdoor



Commercial



Wall



Slight Variation

100x300 cm, 120x360 cm and 160x320 cm are rectified sizes.
100x300 cm, 120x360 cm ve 160x320 cm ebatlar karelenmiş ebatlardır.

Please check pages between 146-155 for dimension detail chart.

Ebat tablosu için 146-151 sayfaları arasına bakınız.

The use of polished products in areas with heavy pedestrian traffic is not recommended.
Parlak ürünlerin yoğun yaya trafiği olan alanlarda kullanımı önerilmez.

100x300 cm, 120x360 cm and 160x320 cm are rectified sizes.
100x300 cm, 120x360 cm ve 160x320 cm ebatlar karelenmiş ebatlardır.

Please check pages between 146-155 for dimension detail chart.

Ebat tablosu için 146-151 sayfaları arasına bakınız.

The use of polished products in areas with heavy pedestrian traffic is not recommended.
Parlak ürünlerin yoğun yaya trafiği olan alanlarda kullanımı önerilmez.

WOOD LOOK
AHŞAP GÖRÜNÜM



Wood Look

Ahşap Görünüm



CALACATTA UNIQUE

WOODLINE OAK

WOODLINE MEŞE

Wood

Ahşap



HOLLYWOOD BEIGE
HOLLYWOOD BEJ

	mm	Matte	Soft Matte	Polished	Satin
100x300 cm	3 5	• •			
120x360 cm	3 5	• •			
160x320 cm 162x323 cm	6 12 20				



HOLLYWOOD BROWN
HOLLYWOOD KAHVE

	mm	Matte	Soft Matte	Polished	Satin
100x300 cm	3 5				
120x360 cm	3 5	• •			
160x320 cm 162x323 cm	6 12 20	•			



WOODLINE WALNUT
WOODLINE CEVİZ

	mm	Matte	Soft Matte	Polished	Satin
100x300 cm	3 5	• •			
120x360 cm	3 5				
160x320 cm 162x323 cm	6 12 20				



WOODLINE CHERRY
WOODLINE KİRAZ

	mm	Matte	Soft Matte	Polished	Satin
100x300 cm	3 5	• •			
120x360 cm	3 5				
160x320 cm 162x323 cm	6 12 20				



WOODLINE OAK
WOODLINE MEŞE

	mm	Matte	Soft Matte	Polished	Satin
100x300 cm	3 5	• •			
120x360 cm	3 5				
160x320 cm 162x323 cm	6 12 20				



Interior & Design



Facade



Kitchen



Furniture



Bathroom



Indoor



Outdoor



Commercial



Gleaming



Wall



Floor



Slight Variation



Interior & Design



Facade



Kitchen



Furniture



Bathroom



Indoor



Outdoor



Commercial



Wall



Floor



Slight Variation

100x300 cm, 120x360 cm and 160x320 cm are rectified sizes.
100x300 cm, 120x360 cm ve 160x320 cm ebatlar karelenmiş ebatlardır.

The use of polished products in areas with heavy pedestrian traffic is not recommended.
Parlak ürünlerin yoğun yaya trafiği olan alanlarda kullanımı önerilmez.

Please check pages between 146-155 for dimension detail chart.

Ebat tablosu için 146-151 sayfaları arasına bakınız.

100x300 cm, 120x360 cm and 160x320 cm are rectified sizes.
100x300 cm, 120x360 cm ve 160x320 cm ebatlar karelenmiş ebatlardır.

The use of polished products in areas with heavy pedestrian traffic is not recommended.
Parlak ürünlerin yoğun yaya trafiği olan alanlarda kullanımı önerilmez.

Please check pages between 146-155 for dimension detail chart.

Ebat tablosu için 146-151 sayfaları arasına bakınız.

Wood

Ahşap



PLANK 104

	mm	Matte	Soft Matte	Polished	Satin
100x300 cm	3	•			
	5	•			
120x360 cm	3				
	5				
160x320 cm 162x323 cm	6				
	12				
	20				



PLANK 110

	mm	Matte	Soft Matte	Polished	Satin
100x300 cm	3	•			
	5	•			
120x360 cm	3				
	5				
160x320 cm 162x323 cm	6				
	12				
	20				



PLANK 111

	mm	Matte	Soft Matte	Polished	Satin
100x300 cm	3	•			
	5	•			
120x360 cm	3				
	5				
160x320 cm 162x323 cm	6				
	12				
	20				



PLANK 114

	mm	Matte	Soft Matte	Polished	Satin
100x300 cm	3	•			
	5	•			
120x360 cm	3				
	5				
160x320 cm 162x323 cm	6				
	12				
	20				



SHELL WOOD DARK

	mm	Matte	Soft Matte	Polished	Satin
100x300 cm	3	•			
	5	•			
120x360 cm	3	•			
	5	•			
160x320 cm 162x323 cm	6				
	12				
	20				



Interior & Design



Facade



Kitchen



Furniture



Bathroom



Indoor



Outdoor



Commercial



Wall



Floor



Slight Variation

100x300 cm, 120x360 cm and 160x320 cm are rectified sizes.
100x300 cm, 120x360 cm ve 160x320 cm ebatlar karelenmiş ebatlardır.

The use of polished products in areas with heavy pedestrian traffic is not recommended.
Parlak ürünlerin yoğun yaya trafiği olan alanlarda kullanımı önerilmez.

Please check pages between 146-155 for dimension detail chart.

Ebat tablosu için 146-151 sayfaları arasına bakınız.



Interior & Design



Facade



Kitchen



Furniture



Bathroom



Indoor



Outdoor



Commercial



Wall



Floor



Slight Variation

100x300 cm, 120x360 cm and 160x320 cm are rectified sizes.
100x300 cm, 120x360 cm ve 160x320 cm ebatlar karelenmiş ebatlardır.

The use of polished products in areas with heavy pedestrian traffic is not recommended.
Parlak ürünlerin yoğun yaya trafiği olan alanlarda kullanımı önerilmez.

Please check pages between 146-155 for dimension detail chart.

Ebat tablosu için 146-151 sayfaları arasına bakınız.



Kalesinterflex perfectly reproduces the excellence and richness of colors and textures, along with the veining and shading of marble, natural stone and the most innovative designer materials, to create alluring atmospheres/environments.

A unique, seamless material that remains unchanged over time, suitable for indoor and outdoor spaces and ideal for surfaces that require optimum hygiene, durability and aesthetic harmony.

Offering superb freedom to mix and match, Kalesinterflex surfaces create habitats with unique style and elegance.

Kalesinterflex, mükemmel bir şekilde renklerin ve dokuların zenginliğini, mermer, doğal taş ve en yenilikçi tasarımcı malzemelerin damarlarını ve tonlarını mükemmel bir şekilde yeniden üretiyor ve büyüleyici atmosferler/yerler yaratıyor. Zaman içinde değişmeden kalan, iç ve dış mekanlar için uygun ve optimum hijyen, dayanıklılık ve estetik uyum gerektiren yüzeyler için ideal olan benzersiz, dikişsiz bir malzeme.

Karıştırma ve eşleştirme konusunda üstün özgürlük sunan Kalesinterflex yüzeyler, benzersiz stil ve zarafete sahip yaşam alanları yaratır.

Boyutlar değişir, kalite değişmez.

120x360cm / 48"x144"

100x300cm / 40"x120"

160x320cm / 62.99" x 125.98"

Dimensions change,
but quality remains the same.

Features / Özellikler

Everything that must be in a ceramic tile and more... Designed to shape the architecture of the future, Kalesinterflex is equipped with superior features to ensure flawless performance under any condition.

Bir seramikte olması gereken her şey ve daha fazlası... Geleceğin mimarisini şekillendirmek için tasarlanan Kalesinterflex, her koşulda kusursuz performans göstermesi için üstün özelliklerle donatıldı.

WEIGHT*

A 3mm-thick Kalesinterflex slab weighs 7kg/sqm while a 5mm-thick Kalesinterflex slab weighs 11.5kg/sqm.



AĞIRLIK*

3mm kalınlığındaki bir Kalesinterflex porselen plaka 7kg/m², 5mm kalınlığındaki bir Kalesinterflex porselen plaka 11,5kg/m² ağırlığındadır.

FLEXIBILITY

The convex flexibility radius of a 3mm-thick Kalesinterflex Fit slab is 5.5m.



ESNEKLİK

3mm kalınlığındaki Kalesinterflex Fit porselen plaka dışbükey esneklik yarıçapı 5.5m'dir.

NON-FLAMMABLE (FLAME RESISTANT)

Kalesinterflex is totally fire resistant and non-flammable.



YANMAZ (ALEVE DAYANIKLI)

Kalesinterflex ateşe tamamen dayanıklı, alev almaz ve yanmaz niteliktedir.

CHEMICAL RESISTANCE

Kalesinterflex is resistant to chemicals (acids and bases) due to its porcelain ceramic structure and glaze layer on its surface.



KİMYASALLARA DAYANIKLILIK

Kalesinterflex yüzeyindeki koruyucu sır tabakası ve porselen yapısı sayesinde en güçlü kimyasallara (asitlere ve bazlara) karşı dayanıklıdır.

CUTTING

It can be cut with standard glass, ceramic cutters and computer controlled automatic cutting machines in the required dimensions.



KESME

Kalesinterflex, standart cam ve seramik kesicileri ve bilgisayar kontrollü otomatik kesme ve delme makineleri ile istenen boyutlarda kesilebilir.

DRILLING

Kalesinterflex can be drilled with glass drills as well as with other automatic drilling devices.



DELME

Kalesinterflex, cam ya da benzer malzemeler için kullanılan alet ve matkaplar ile delinebileceği gibi diğer bilinen otomatik aletlerle de delinebilir.

HIGH HEAT AND FROST RESISTANCE

Kalesinterflex's surface is equipped with advanced technology to accommodate various climate conditions. It maintains its durability against sudden changes in heat and frost.



YÜKSEK SICAKLIĞA VE SOĞUĞA DAYANMA DİRENCİ

Kalesinterflex'in üstün teknolojiyle donatılan yüzeyi farklı iklim koşullarına uygun olarak tasarlanmıştır. Ani ısı değişikliklerine ve dona karşı sağlamlığını korur.

EASE OF CLEANING

Kalesinterflex has a smooth surface on which dirt does not accumulate. If required it can be cleaned with water and known cleaning agents.

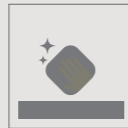

TEMİZLEME

Kalesinterflex'in düzgün yüzeyi kir tutmayan bir yapıya sahiptir. Gerekli takdirde su ve bilinen temizlik ürünleri ile kolayca temizlenebilir, lekelenmez.

*The specified weights reflect average values and may vary depending on the product.

*Belirtilen rakamlar ortama değerlerdir. Farklı ürünlerde değişiklik gösterebilir.

ANTI-GRAFFITI

Easy to wipe and clean pollutants like crayon, graffiti, permanent marker, board marker.



ANTI-GRAFİTİ

Boya kalem, keçeli kalem ve tahta kalem yazılan kolayca silinir ve temizlenir.

PHOTOCATALYTIC

Kalesinterflex is photocatalytic thanks to its Nano-tech coating surface. Kalesinterflex cleans itself with rain and sunlight.



FOTOKATALİTİK

Kalesinterflex Nano Kompozit yüzey özelliği sayesinde fotokataliktir. Leke tutmaz, yağmur ve güneş ışığı sayesinde lekeler temizlenir.

HYGIENIC

Protects both outdoor and indoor, even in poorly lit environment. Hygienic; resistant to bacteria, mould and fungus. The antibacterial feature of Kalesinterflex is approved by TÜBİTAK. (The Scientific and Technological Research Council of Turkey)



HİJYENİK

Yetersiz aydınlatmaya sahip ortamlarda dahi hem iç mekanları hem de dış mekanları bakterilerden korur. Hijyeniktir; bakterilere, küfe ve mantara karşı dayanıklıdır. Kalesinterflex Antibakteriyel Ürün Güvencesi TÜBİTAK tarafından onaylıdır.

ECO-FRIENDLY

Produced with an environmentally-friendly technology, Kalesinterflex has Ecospecifier certificate. Compared to the traditional ceramic production process, its gas and dust emission is 20 times, its CO2 emission is 1000 times less.



ÇEVRE DOSTU

Çevreye duyarlı bir teknoloji ile üretilen Kalesinterflex, Ecospecifier belgesine sahiptir. Geleneksel seramik üretim süreçleriyle karşılaştırıldığında gaz ve toz emisyonu 20 kat, CO2 emisyonu ise 1000 kat daha azdır.

HIGH STAIN RESISTANCE



YÜKSEK LEKE DİRENCİ

HIGH ABRASION RESISTANCE

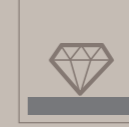

YÜKSEK AŞINMA DİRENCİ

HIGH RESISTANCE TO UV RAYS



UV IŞINLARINA YÜKSEK DİRENCİ

LOW WATER ABSORPTION (NEAR ZERO)



DÜŞÜK SU EMMELİ (0'A YAKIN)

EVERLASTING



UZUN ÖMÜRLÜ

HIGH SCRATCH RESISTANCE



YÜKSEK ÇİZİLME DİRENCİ



Kaleguard

*We use science and technology for human health.
The health of you and your loved ones are under protection
thanks to Kaleguard Surface Protection Technology.*

Bilim ve teknolojiyi insan sağlığı için kullanıyoruz.
Kaleguard Yüzey Koruma Teknolojisi ile sizin ve sevdiklerinizin
sağlığı koruma altında.

*We equip ceramic surfaces with superior
protection with Kaleguard technology which
is developed for the first time in the world.*

Dünyada sadece Kale'de bulunan Kaleguard
teknolojisiyle, seramik yüzeyleri üstün koruma
özelliliyle donatıyoruz.

3 SUPERIOR FEATURES DESIGNED FOR LIVING SPACES!

YAŞAM ALANLARI İÇİN TASARLANAN
3 ÜSTÜN ÖZELLİK!

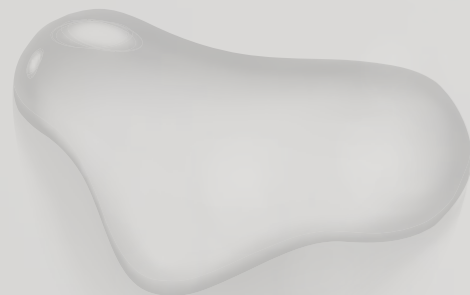

Effective protection against bacteria!
Bakterilere karşı etkili koruma!

*Preventing the formation of bacteria mold,
fungus and bacteria; Kaleguard technology offers
maximum hygiene everywhere. It protects your
health in many living areas open to public use
such as homes, hotels, hospitals, shopping malls,
poolside and schools.*

Küf, mantar ve bakteri oluşumunu önleyen
Kaleguard teknolojisi, her yerde maksimum hijyen
sunuyor. Ev, otel, hastane, alışveriş merkezi, havuz
kenarı ve okul gibi toplu kullanıma açık birçok
yaşam alanında sağlığınıza koruyor.

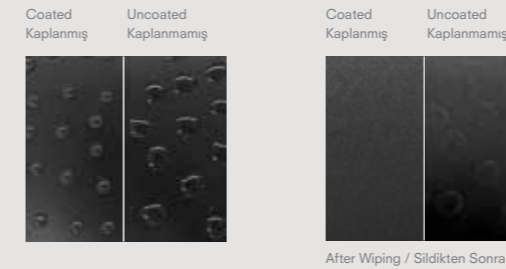

More easily cleanable eco-friendly surfaces!
Daha rahat temizlenen çevreci yüzeyler!

*Providing water and oil repellency to ceramic surfaces; Kaleguard technology creates a healthy environment in wet
spaces such as bathrooms and kitchens. Protecting the environment, Kaleguard technology offers a comfortable
and easy cleaning experience since less water and cleaning materials are used compared to standard surfaces.*

Seramik yüzeylere su ve yağ iticilik özelliği kazandıran Kaleguard teknolojisi; banyo ve mutfak gibi ıslak hacimli
mekanlarda sağlıklı bir ortam oluşturuyor. Standart yüzeylere göre daha az su ve temizlik malzemesi kullanıldığı için
çevreyi koruyan Kaleguard teknolojisi, rahat ve yormayan bir temizlik deneyimi sunuyor.

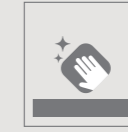
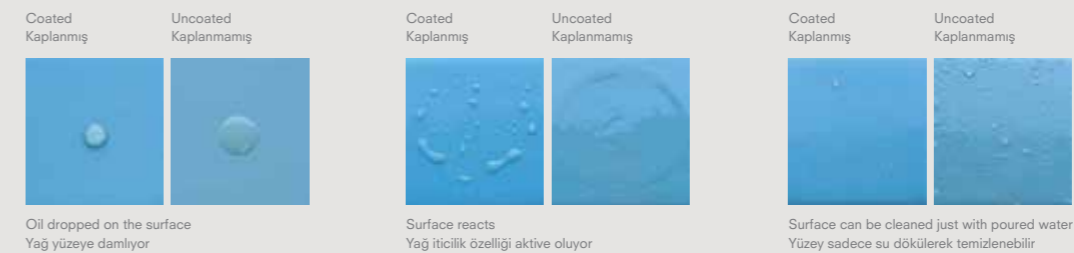

Self-cleaning hygienic ceramics!
Kendi kendini temizleyen hijyenik seramikler!

*Stains and dirt caused by different environmental
effects cannot hold on to ceramic surfaces thanks
to Kaleguard technology. While providing a clean
appearance indoors and outdoors, it designs healthy
living spaces with its unique technology.*

Farklı çevresel etkilerle oluşacak leke ve kirlere Kaleguard
teknolojisi ile seramik yüzeylerde tutunmıyor. İç ve dış
mekanlarda temiz bir görünüm sağlarken, benzersiz
teknolojisiyle sağlıklı yaşam alanları tasarlıyor.

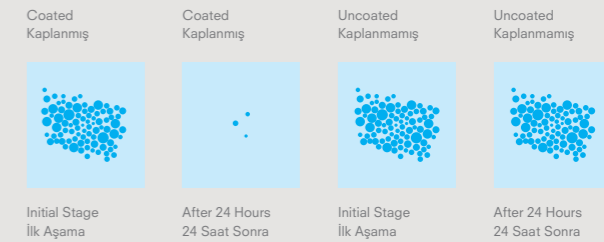

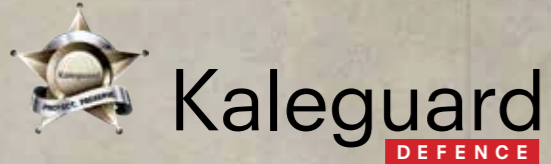

VIRUSES HAVE NO PLACE IN YOUR LIVING SPACE THANKS TO KALEGUARD DEFENCE!

Kaleguard Defence ile virüslerin yaşam alanınızda yeri yok!



Kalebodur products; which keep the spaces alive with functional products and inspire with unique ceramic collections; offer you and your loved ones a healthy life with antimicrobials.

Fonksiyonel ürünlerle mekanları yaşatan, eşsiz seramik koleksiyonlarıyla ilham veren yapılarda yer alan Kalebodur ürünleri, antimikrobiyal ile size ve sevdiğinizlere sağlıklı bir hayat sunuyor.



Healthy living spaces in all parts of life!

With Kaleguard Defence, there is no virus and bacteria; there is healthy and comfortable life. You can safely touch ceramic surfaces with Kaleguard Defence; guaranteed and certified by national and international organisations.

Hayatın her yerinde sağlıklı yaşam alanları!

Kaleguard Defence ile virüs ve bakteri yok, sağlıklı ve konforlu bir hayat var. Ulusal ve uluslararası kuruluşlarca onaylanan Kaleguard Defence güvencesiyle, seramik yüzeylere güvenle dokunun.



Kitchen / Mutfak



Bathroom / Banyo



Living Room / Salon



Airport / Havalimanı



Shopping Mall / AVM



Hospital / Hastane



Hotel / Otel



School / Okul



Pool & SPA / Havuz & SPA



Gym / Spor Salonu

Thanks to Kaleguard assurance, there is hygiene and health on the surfaces you contact. Kaleguard güvencesiyle, temas ettiğiniz yüzeylerde hijyen ve sağlık var.

Superior features that protect your health! Sağlığınızı koruyan üstün özellikler!



Kaleguard Defence Protection
Provides effective protection against viruses and bacteria.

Kaleguard Defence Koruma
Virüs ve bakterilere karşı etkin koruma sağlar.



Environment-friendly
It has no harmful effect on the environment.

Çevre Dostu
Çevreye zararlı bir etkisi yoktur.



Chemical Resistance
It has chemical resistance. It does not corrode due to cleaners.

Kimyasal Dayanım
Kimyasal dirence sahiptir. Temizleyiciler ile aşınmaz.



Hygienic
It has stain resistance. In this way, surfaces can be cleaned easily.

Hijyenik
Lekelenme direncine sahiptir. Bu sayede yüzeyler kolay temizlenebilir.



Invisible Surface Application
Since it can be applied very thin, the aesthetic properties of the product do not deform.

Görünmez Yüzey Uygulaması
Çok ince uygulanabildiği için ürünün estetik özellikleri bozulmaz.



Long-lasting
It preserves its antimicrobial features for 2 years in wall and floor applications.

Uzun Ömürlü
Duvar ve zemin uygulamalarında 2 yıl antimikrobiyal özelliğini korur.

Services

Hizmetler

Houses, offices, shopping malls, and airports...We see all of them as meeting points where we touch life. We carry the care we take while producing our designs to product applications, and we aim to make our entire operation process, from production to implementation, perfect.

With the help of our expert technical sales staff, we guide the sales processes by ensuring the right product, practitioner, and project matches in facade projects.

Working in cooperation with the relevant departments and staff of the universities, specific to our product groups, we ensure that technical details and specifications are prepared and shared. We come together with stakeholders such as architects, contractors, and facade practitioners, share with them technical specifications, principle detail drawings, and static calculation studies in accordance with our products, and offer technical guidance in special detail and grid works.

We provide technical support for the smooth progress of field applications and work with the practitioners in coordination to supervise compliance with the specifications.

Evler, ofisler, alışveriş merkezleri ve havaalanları...Hepsini hayata dokunduğumuz buluşma noktaları olarak görüyoruz. Tasarımlarımızı üretirken gösterdiğimiz özeni ürün uygulamalarına taşıyor; üretimden uygulamaya bütün operasyon sürecimizin kusursuz olmasını hedefliyoruz.

Uzman teknik satış kadromuz ile satış sürecinin her aşamasında doğru ürünün, doğru uygulama ve detayla eşleştirilmesini hedefliyoruz.

Ürün gruplarımızın teknik özelliklerini ve kullanım avantajlarını en iyi şekilde ortaya koyabilmek için uzman kadrolarla iş birliği yaparak detaylı teknik dokümanlar ve şartnameler hazırlıyoruz. Bilgileri sektör profesyonelleriyle paylaşarak ürünlerimizin teknik yeterliliklerinin akademik çevrelerce de desteklenmesini sağlıyoruz. Mimari gruplar, müteahhitler, uygulamacılar, cephe danışmanları, cephe uygulamacıları gibi sektörün önemli paydaşları ile sürekli iletişim halinde olup, projelerin başarıyla tamamlanmasını sağlayacak teknik şartnameler, prensip detay çizimleri ve statik hesap çalışmalarını paylaşıyoruz.

Saha uygulamalarının sorunsuz ilerlemesi için teknik destek veriyor ve şartnameye uygunluğunu denetlemek üzere uygulayıcı ekiplerle koordineli şekilde çalışıyoruz.

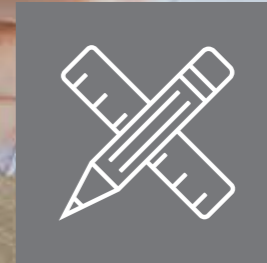
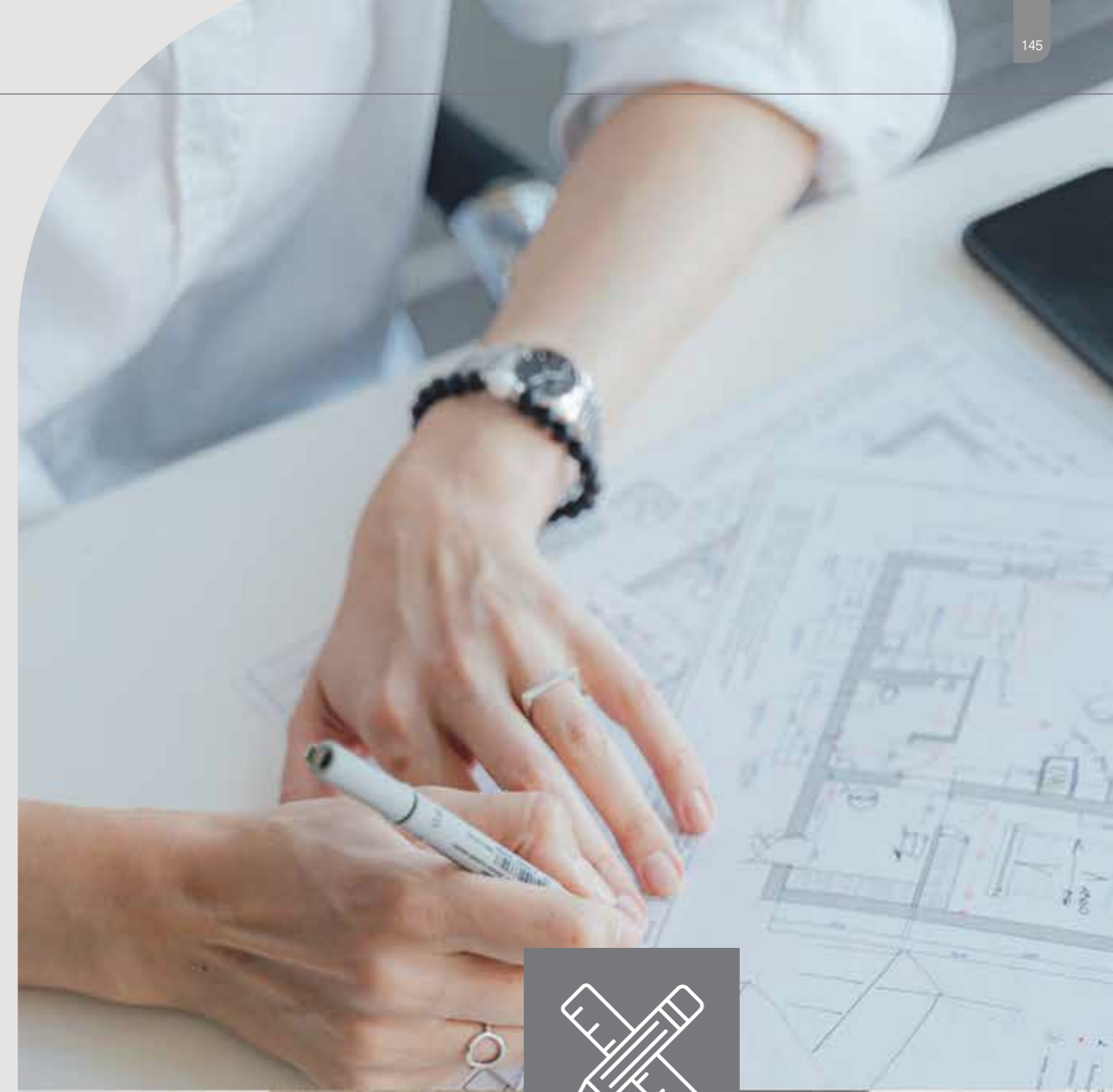

Size Table

Ölçü Tablosu

TIPOLOJİ TYPOLOGY	SERİ SERIES	ÜRÜN PRODUCT	100x300		120x360		160x320/162x323			162x323			162x323			OPENBOOK
			3 MM	5 MM	3 MM	5 MM	6 MM			12 MM			20 MM			
			MAT / MATTE		MAT / MATTE		SOFT MAT / SOFT MATTE	PARLAK / POLISHED	SATEN / SATIN	SOFT MAT / SOFT MATTE	PARLAK / POLISHED	SATEN	SOFT MAT / SOFT MATTE	PARLAK / POLISHED	KAYA YÜZEY / ROCK SURFACE	
MARBLE B&W / MERMER B&W	MARBLES	CALACATTA 2.O	X	X	X	X										
MARBLE B&W / MERMER B&W	CALCATTÀ UNIQUE	CALACATTA UNIQUE NEW / YENİ	X	X	X	X	X	X		X	X	X	X		X	
MARBLE B&W / MERMER B&W	CALCATTÀ CALDIA	CALACATTA CALDIA NEW / YENİ	X	X	X	X	X	X		X	X	X				
MARBLE B&W / MERMER B&W	CALACATTA GOLD	CALACATTA GOLD	X		X		X	X		X	X	X				
MARBLE B&W / MERMER B&W	MARBLES	CALACATTA ICE	X		X											
MARBLE B&W / MERMER B&W	FLORENCE	FLORENCE NEW / YENİ					X	X		X	X				X	
MARBLE B&W / MERMER B&W	GOLDEN HOUR	GOLDEN HOUR NEW / YENİ					X	X		X	X				X	
MARBLE B&W / MERMER B&W	BRONZE LINE	BRONZE LINE NEW / YENİ					X	X		X	X					
MARBLE B&W / MERMER B&W	CALACATTA VIOLA	CALACATTA VIOLA NEW / YENİ									X					
MARBLE B&W / MERMER B&W	CALACATTA MACCHIA	CALACATTA MACCHIA		X		X	X	X		X	X					
MARBLE B&W / MERMER B&W	MARBLES	COLORODO ORO	X												X	
MARBLE B&W / MERMER B&W	MARBLES	MARBLE DARK	X	X	X	X										
MARBLE B&W / MERMER B&W	PIETRA NERO	PIETRA NERO NEW / YENİ	X	X	X	X	X	X		X	X	X			X	
MARBLE B&W / MERMER B&W	PALISSANDRO	PALISSANDRO	X	X	X	X	X			X						
MARBLE B&W / MERMER B&W	PORT LAURENT	PORT LAURENT	X	X	X	X	X	X		X	X					
MARBLE B&W / MERMER B&W	MARBLES	WINTERLAND	X	X	X	X										
MARBLE B&W / MERMER B&W	MARBLES	MARBLE STATUARIO								X	X					
MARBLE EXCLUSIVE / MERMER EXCLUSIVE	SAHARA BROWN / SAHARA KAHVE	SAHARA BROWN / SAHARA KAHVE	X				X			X						
MARBLE EXCLUSIVE / MERMER EXCLUSIVE	MARBLES	ALAMEDA	X		X											
MARBLE EXCLUSIVE / MERMER EXCLUSIVE	MARBLES	ASTEROID	X	X	X	X										
MARBLE EXCLUSIVE / MERMER EXCLUSIVE	MARMO METALLO	MARMO METALLO	X	X	X	X	X			X						
MARBLE EXCLUSIVE / MERMER EXCLUSIVE	MARBLES	MOCHA PERLA	X	X	X	X										
MARBLE EXCLUSIVE / MERMER EXCLUSIVE	MARBLES	OLIMPO	X	X	X	X	X	X		X						
MARBLE EXCLUSIVE / MERMER EXCLUSIVE	SARRANCOLIN	SARRANCOLIN- NEW / YENİ					X	X		X	X					
MARBLE EXCLUSIVE / MERMER EXCLUSIVE	PATAGONIA	PATAGONIA NEW / YENİ						X		X	X				X	
MARBLE EXCLUSIVE / MERMER EXCLUSIVE	QUARZITE J'ADORE	QUARZITE J'ADORE NEW / YENİ						X			X				X	
MARBLE EXCLUSIVE / MERMER EXCLUSIVE	MARBLES	SEA NATURE	X	X												
MARBLE EXCLUSIVE / MERMER EXCLUSIVE	MARBLES	VERSAILLES						X		X						
MARBLE EXCLUSIVE / MERMER EXCLUSIVE	MARINA	MARINA NEW / YENİ						X			X					
MARBLE EXCLUSIVE / MERMER EXCLUSIVE	ALASKA WHITE	ALASKA WHITE NEW / YENİ						X			X					
MARBLE EXCLUSIVE / MERMER EXCLUSIVE	TIFFANY BLUE	TIFFANY BLUE NEW / YENİ						X							X	
MARBLE EXCLUSIVE / MERMER EXCLUSIVE	NAMIBIA	NAMIBIA NEW / YENİ						X			X					

Size Table

Ölçü Tablosu

TIPOLOJİ TYPOLOGY	SERİ SERIES	ÜRÜN PRODUCT	100x300		120x360		160x320/162x323			162x323			162x323			OPENBOOK
			3 MM	5 MM	3 MM	5 MM	6 MM			12 MM			20 MM			
			MAT / MATTE		MAT / MATTE		SOFT MAT / SOFT MATTE	PARLAK / POLISHED	SATEN / SATIN	SOFT MAT / SOFT MATTE	PARLAK / POLISHED	SATEN	SOFT MAT / SOFT MATTE	PARLAK / POLISHED	KAYA YÜZEY / ROCK SURFACE	
MARBLE TIMELESS / MERMER TIMELESS	MARBLES	PULPIS	X		X											
MARBLE TIMELESS / MERMER TIMELESS	FIORI DI BOSCO	FIORI DI BOSCO NEW / YENİ					X	X		X	X					
MARBLE TIMELESS / MERMER TIMELESS	DIAMOND COLLECTION	DENISE NEW / YENİ						X		X	X					
MARBLE TIMELESS / MERMER TIMELESS	MARBLES	TRANSLUCENT ONYX	X													
MARBLE TIMELESS / MERMER TIMELESS	MARBLES	TRAVERTINO			X											
MARBLE TIMELESS / MERMER TIMELESS	DIAMOND COLLECTION	CRYSTALLUS NEW / YENİ						X			X					
STONE / DOĞALTAŞ	MARBLES	LIMESTONE	X	X	X	X										
STONE / DOĞALTAŞ	C-STONE	C-STONE ANTHRACITE / C-STONE ANTRASİT	X	X	X	X										
STONE / DOĞALTAŞ	C-STONE	C-STONE BEIGE / C-STONE BEJ	X	X	X	X										
STONE / DOĞALTAŞ	C-STONE	C-STONE WHITE / C-STONE BEYAZ	X	X	X	X										
STONE / DOĞALTAŞ	C-STONE	C-STONE GREY / C-STONE GRİ	X	X	X	X										
STONE / DOĞALTAŞ	C-STONE	C-STONE BROWN / C-STONE KAHVE	X	X	X	X										
STONE / DOĞALTAŞ	KSF UPTOWN	UPTOWN DARK	X	X	X	X										
STONE / DOĞALTAŞ	KSF UPTOWN	UPTOWN LIGHT	X	X	X	X										
STONE / DOĞALTAŞ	NATURAL STONE	BRERA CRÈME	X	X												
STONE / DOĞALTAŞ	NATURAL STONE	LECCESE DARK SAND	X	X	X	X										
STONE / DOĞALTAŞ	NATURAL STONE	LECCESE GREY	X	X												
STONE / DOĞALTAŞ	NATURAL STONE	LECCESE LIGHT SAND	X	X												
STONE / DOĞALTAŞ	NATURAL STONE	PIETRA BLUE	X	X	X	X										
STONE / DOĞALTAŞ	NATURAL STONE	PIETRA GREY	X	X												
STONE / DOĞALTAŞ	OCEAN	OCEAN BLACK	X	X												
STONE / DOĞALTAŞ	OCEAN	OCEAN WHITE	X	X												
STONE / DOĞALTAŞ	OMNITECH	PIAMONTE	X													
STONE / DOĞALTAŞ	OMNITECH	MONOLITH	X													
STONE / DOĞALTAŞ	PIETRA BASALTINA	PIETRA BASALTINA	X									X		X		
STONE / DOĞALTAŞ	PIETRA DI CHATIL	PIETRA CHATILLONN	X	X												
STONE / DOĞALTAŞ	STONE GALLERY	QUARTZ ASH	X													
STONE / DOĞALTAŞ	CALCARIO COLLECTION	CALCARIO COLLECTION LINE NEW / YENİ GREIGE						X								
STONE / DOĞALTAŞ	CALCARIO COLLECTION	CALCARIO COLLECTION NEW / YENİ GREIGE						X			X			X		
STONE / DOĞALTAŞ	CALCARIO COLLECTION	CALCARIO COLLECTION LIGHT GREIGE						X			X			X		
STONE / DOĞALTAŞ	CALCARIO COLLECTION	CALCARIO COLLECTION LIGHT LINE GREIGE						X								
STONE / DOĞALTAŞ	STONELAND	PIETRA Dİ GRE KEMİK	X		X		X				X		X			
STONE / DOĞALTAŞ	STONELAND	PIETRA Dİ GRE GRİ	X		X		X				X		X			

Kalesinterflex 100*300 - 120*360 3mm Technical Specifications

Kalesinterflex 100*300 - 120*360 3mm Teknik Özellikler

	Norm - test method	Requirements for nominal size N Nominal boyut N gereklilikleri		KALE 1000X3000R (mm) Rectified		KALE 1200X3600R (mm) Rectified	
		N≥15 cm		Matte Mat	Polished Parlatılmış	Matte Mat	Polished Parlatılmış
		% (for rectified)	mm (for rectified)				
Length and width Uzunluk ve genişlik	ISO 10545-2	± 0,3	± 1	Suitable Uygun	Suitable Uygun	Suitable Uygun	Suitable Uygun
Thickness Kalınlık		± 0,5	± 0,5	Suitable Uygun	Suitable Uygun	Suitable Uygun	Suitable Uygun
Straightness of sides Kenarların düzgünlüğü		± 0,3	± 0,8	Suitable Uygun	Suitable Uygun	Suitable Uygun	Suitable Uygun
Rectangularity (Measurement only on short edges when L/l ≥ 3) Gönyeden sapma (Sadece L/l ≥ 3 olduğunda ölçülür)		± 0,3	± 1,5	Suitable Uygun	Suitable Uygun	Suitable Uygun	Suitable Uygun
Surface flatness Yüzey düzgünlüğü		c.c. ± 0,4	c.c. ± 1,8	Suitable Uygun	Suitable Uygun	Suitable Uygun	Suitable Uygun
		e.c. ± 0,4	e.c. ± 1,8				
	w. ± 0,4	w. ± 1,8					
Water absorption	ISO 10545-3	Ev ≤ 0,5 % Individual max 0,6 % Ev ≤ 0,5 % tek olarak max 0,6 %		≤ 0,3 %	≤ 0,3 %	≤ 0,3 %	≤ 0,3 %
Breaking strength (Thickness < 7,5 mm)	ISO 10545-4	Not less than 700 N		≥ 700N	≥ 700N	≥ 700N	≥ 700N
Modulus of rupture		R ≥ 35 N/mm ²		≥ 45 N/mm ²	≥ 45 N/mm ²	≥ 45 N/mm ²	≥ 45 N/mm ²
Impact resistance, as coefficient of restitution	ISO 10545-5	Declared value Beyan edilen değer		≥ 55	≥ 55	≥ 55	≥ 55
Resistance to deep abrasion of unglazed tiles(removed volume)	ISO 10545-6	≤ 175 mm ³		Suitable Uygun	"Suitable Uygun"	Suitable Uygun	"Suitable Uygun"
Coefficient of thermal linear expansion	ISO 10545-8	Declared value Beyan edilen değer		≤ 7 x 10 ⁻⁶	≤ 7 x 10 ⁻⁶	≤ 7 x 10 ⁻⁶	≤ 7 x 10 ⁻⁶
Thermal shock resistance	ISO 10545-9	Pass according to EN ISO 10545-1 EN ISO 10545-1'e göre geçer		Resistant Dayanıklı	Resistant Dayanıklı	Resistant Dayanıklı	Resistant Dayanıklı
Moisture expansion (in mm/m)	ISO 10545-10	Declared value Beyan edilen değer		≤ 0,01% (0,1mm/m)	≤ 0,01% (0,1mm/m)	≤ 0,01% (0,1mm/m)	≤ 0,01% (0,1mm/m)
Frost resistance	ISO 10545-12	Pass according to EN ISO 10545-1 EN ISO 10545-1'e göre geçer		Resistant Dayanıklı	Resistant Dayanıklı	Resistant Dayanıklı	Resistant Dayanıklı
Bond strength/adhesion for improved cementitious adhesives	EN 1348	Declared value Beyan edilen değer		≥ 0,5 N/mm ²	≥ 0,5 N/mm ²	≥ 0,5 N/mm ²	≥ 0,5 N/mm ²
Reaction to fire	-	A1 or Afl		A1 without fiberglass	A1 without fiberglass	A1 without fiberglass	A1 without fiberglass
Resistance to household chemicals and swimming pool salts		Minimum Class B Minimum sınıf B		A	A	A	A
Resistance to low concentrations of acids and alkalis	ISO 10545-13	Declared value Beyan edilen değer		LA	LA	LA	LA
Resistance to high concentrations of acids and alkalis		Declared value Beyan edilen değer		HA	-	HA	-
Resistance to staining	ISO 10545-14	Declared value Beyan edilen değer		5	5	5	5
Release of dangerous substances: Cadmium (in mg/dm ²) and Lead (in mg/dm ²)	ISO 10545-15	Declared value Beyan edilen değer		≤ 0,01 mg/dm ² Cd ≤ 0,1 mg/dm ² Pb	≤ 0,01 mg/dm ² Cd ≤ 0,1 mg/dm ² Pb	≤ 0,01 mg/dm ² Cd ≤ 0,1 mg/dm ² Pb	≤ 0,01 mg/dm ² Cd ≤ 0,1 mg/dm ² Pb

Kalesinterflex 100*300 - 120*360 5mm Technical Specifications

Kalesinterflex 100*300 - 120*360 5mm Teknik Özellikler

	Norm - test method	Requirements for nominal size N Nominal boyut N gereklilikleri		KALE 1000X3000R (mm) Rectified		KALE 1200X3600R (mm) Rectified	
		N≥15 cm		Matte Mat	Polished Parlatılmış	Matte Mat	Polished Parlatılmış
		% (for rectified)	mm (for rectified)				
Length and width Uzunluk ve genişlik	ISO 10545-2	± 0,3	± 1	Suitable Uygun	Suitable Uygun	Suitable Uygun	Suitable Uygun
Thickness Kalınlık		± 0,5	± 0,5	Suitable Uygun	Suitable Uygun	Suitable Uygun	Suitable Uygun
Straightness of sides Kenarların düzgünlüğü		± 0,3	± 0,8	Suitable Uygun	Suitable Uygun	Suitable Uygun	Suitable Uygun
Rectangularity (Measurement only on short edges when L/l ≥ 3) Gönyeden sapma (Sadece L/l ≥ 3 olduğunda ölçülür)		± 0,3	± 1,5	Suitable Uygun	Suitable Uygun	Suitable Uygun	Suitable Uygun
Surface flatness Yüzey düzgünlüğü		c.c. ± 0,4	c.c. ± 1,8	Suitable Uygun	Suitable Uygun	Suitable Uygun	Suitable Uygun
		e.c. ± 0,4	e.c. ± 1,8				
	w. ± 0,4	w. ± 1,8					
Water absorption	ISO 10545-3	Ev ≤ 0,5 % Individual max 0,6 % Ev ≤ 0,5 % tek olarak max 0,6 %		≤ 0,3 %	≤ 0,3 %	≤ 0,3 %	≤ 0,3 %
Breaking strength (Thickness < 7,5 mm)	ISO 10545-4	Not less than 700 N		≥ 700N	≥ 700N	≥ 700N	≥ 700N
Modulus of rupture		R ≥ 35 N/mm ²		≥ 45 N/mm ²	≥ 45 N/mm ²	≥ 45 N/mm ²	≥ 45 N/mm ²
Impact resistance, as coefficient of restitution	ISO 10545-5	Declared value Beyan edilen değer		≥ 55	≥ 55	≥ 55	≥ 55
Resistance to deep abrasion of unglazed tiles(removed volume)	ISO 10545-6	≤ 175 mm ³		Suitable Uygun	"Suitable Uygun"	Suitable Uygun	"Suitable Uygun"
Coefficient of thermal linear expansion	ISO 10545-8	Declared value Beyan edilen değer		≤ 7 x 10 ⁻⁶	≤ 7 x 10 ⁻⁶	≤ 7 x 10 ⁻⁶	≤ 7 x 10 ⁻⁶
Thermal shock resistance	ISO 10545-9	Pass according to EN ISO 10545-1 EN ISO 10545-1'e göre geçer		Resistant Dayanıklı	Resistant Dayanıklı	Resistant Dayanıklı	Resistant Dayanıklı
Moisture expansion (in mm/m)	ISO 10545-10	Declared value Beyan edilen değer		≤ 0,01% (0,1mm/m)	≤ 0,01% (0,1mm/m)	≤ 0,01% (0,1mm/m)	≤ 0,01% (0,1mm/m)
Frost resistance	ISO 10545-12	Pass according to EN ISO 10545-1 EN ISO 10545-1'e göre geçer		Resistant Dayanıklı	Resistant Dayanıklı	Resistant Dayanıklı	Resistant Dayanıklı
Bond strength/adhesion for improved cementitious adhesives	EN 1348	Declared value Beyan edilen değer		≥ 0,5 N/mm ²	≥ 0,5 N/mm ²	≥ 0,5 N/mm ²	≥ 0,5 N/mm ²
Reaction to fire	-	A1 or Afl		A1 without fiberglass	A1 without fiberglass	A1 without fiberglass	A1 without fiberglass
Resistance to household chemicals and swimming pool salts		Minimum Class B Minimum sınıf B		A	A	A	A
Resistance to low concentrations of acids and alkalis	ISO 10545-13	Declared value Beyan edilen değer		LA	LA	LA	LA
Resistance to high concentrations of acids and alkalis		Declared value Beyan edilen değer		HA	-	HA	-
Resistance to staining	ISO 10545-14	Declared value Beyan edilen değer		5	5	5	5
Release of dangerous substances: Cadmium (in mg/dm ²) and Lead (in mg/dm ²)	ISO 10545-15	Declared value Beyan edilen değer		≤ 0,01 mg/dm ² Cd ≤ 0,1 mg/dm ² Pb	≤ 0,01 mg/dm ² Cd ≤ 0,1 mg/dm ² Pb	≤ 0,01 mg/dm ² Cd ≤ 0,1 mg/dm ² Pb	≤ 0,01 mg/dm ² Cd ≤ 0,1 mg/dm ² Pb

Kalesinterflex 160*320 - 162x323 6mm-12mm Technical Table

Kalesinterflex 160*320 - 162x323 6mm-12mm Teknik Tablo

	Norm - test method	Requirements for nominal size N Nominal boyut N gereklilikleri		KALE 1620X3230 (mm) Non-rectified		KALE 1600X3200R (mm) Rectified	
		N≥15 cm		Matte Mat	Polished Parlatılmış	Matte Mat	Polished Parlatılmış
		%(for rectified)	mm(for rectified)				
Length and width Uzunluk ve genişlik	ISO 10545-2	± 0,3	± 1	N.A.	N.A.	Suitable Uygun	Suitable Uygun
Thickness Kalınlık		± 0,5	± 0,5	N.A.	N.A.	Suitable Uygun	Suitable Uygun
Straightness of sides Kenarların düzgünlüğü		± 0,3	± 0,8	N.A.	N.A.	Suitable Uygun	Suitable Uygun
Rectangularity (Measurement only on short edges when L/l ≥ 3) Gönyeden sapma (Sadece L/l ≥ 3 olduğunda ölçülür)		± 0,3	± 1,5	N.A.	N.A.	Suitable Uygun	Suitable Uygun
Surface flatness Yüzey düzgünlüğü		c.c. ± 0,4	c.c. ± 1,8	N.A.	N.A.	Suitable Uygun	Suitable Uygun
		e.c. ± 0,4	e.c. ± 1,8				
		w. ± 0,4	w. ± 1,8				
Water absorption	ISO 10545-3	Ev ≤ 0,5% Individual max 0,6% Ev ≤ 0,5% tek olarak max 0,6%		≤ 0,1 %	≤ 0,1 %	≤ 0,1 %	≤ 0,1 %
Breaking strength	ISO 10545-4	for thickness / kalınlık < 7,5mm S ≥ 700 N for thickness/kalınlık ≥ 7,5mm S ≥ 1300 N		6 mm -> S ≥ 700N 12 mm -> S ≥ 4000N	6 mm -> S ≥ 700N 12 mm -> S ≥ 4000N	6 mm -> S ≥ 700N 12 mm -> S ≥ 4000N	6 mm -> S ≥ 700N 12 mm -> S ≥ 4000N
Modulus of rupture		R ≥ 35 N/mm ²		6 mm -> R ≥ 35 N/mm ² 12 mm -> R ≥ 45 N/mm ²	6 mm -> R ≥ 35 N/mm ² 12 mm -> R ≥ 45 N/mm ²	6 mm -> R ≥ 35 N/mm ² 12 mm -> R ≥ 45 N/mm ²	6 mm -> R ≥ 35 N/mm ² 12 mm -> R ≥ 45 N/mm ²
Impact resistance, as coefficient of restitution	ISO 10545-5	Declared value Beyan edilen değer		≥ 55	≥ 55	≥ 55	≥ 55
Resistance to deep abrasion of unglazed tiles(removed volume)	ISO 10545-6	≤ 175 mm ³		Suitable Uygun	Suitable Uygun	Suitable Uygun	Suitable Uygun
Coefficient of thermal linear expansion	ISO 10545-8	Declared value Beyan edilen değer		≤ 7 MK-1	≤ 7 MK-1	≤ 7 MK-1	≤ 7 MK-1
Thermal shock resistance	ISO 10545-9	Pass according to EN ISO 10545-1 EN ISO 10545-1'e göre geçer		Resistant Dayanıklı	Resistant Dayanıklı	Resistant Dayanıklı	Resistant Dayanıklı
Moisture expansion (in mm/m)	ISO 10545-10	Declared value Beyan edilen değer		≤ 0,01% (0,1mm/m)	≤ 0,01% (0,1mm/m)	≤ 0,01% (0,1mm/m)	≤ 0,01% (0,1mm/m)
Frost resistance	ISO 10545-12	Pass according to EN ISO 10545-1 EN ISO 10545-1'e göre geçer		Resistant Dayanıklı	Resistant Dayanıklı	Resistant Dayanıklı	Resistant Dayanıklı
Bond strength/adhesion for improved cementitious adhesives	EN 1348	Declared value Beyan edilen değer		≥ 0,5 N/mm ²	≥ 0,5 N/mm ²	≥ 0,5 N/mm ²	≥ 0,5 N/mm ²
Reaction to fire	-	A1 or AfI		A1 without fiberglass	A1 without fiberglass	A1 without fiberglass	A1 without fiberglass
Resistance to household chemicals and swimming pool salts	ISO 10545-13	Minimum Class B Minimum sınıf B		A	A	A	A
Resistance to low concentrations of acids and alkalis		Declared value Beyan edilen değer		LA	LA	LA	LA
Resistance to high concentrations of acids and alkalis		Declared value Beyan edilen değer		HA	-	HA	-
Resistance to staining	ISO 10545-14	Declared value Beyan edilen değer		5	5	5	5
Release of dangerous substances: Cadmium (in mg/dm ²) and Lead (in mg/dm ²)	ISO 10545-15	Declared value Beyan edilen değer		≤ 0,01 mg/dm ² Cd ≤ 0,1 mg/dm ² Pb	≤ 0,01 mg/dm ² Cd ≤ 0,1 mg/dm ² Pb	≤ 0,01 mg/dm ² Cd ≤ 0,1 mg/dm ² Pb	≤ 0,01 mg/dm ² Cd ≤ 0,1 mg/dm ² Pb

100*300-120*360

Packaging and Shipping Details

100*300-120*360 Paketleme ve Gönderim Detayı

ÜRÜN EBADI CM	SANDIK EBADI CM	ÜRÜN GRUBU	kg/m²	ADET/m²	BOŞ SANDIK KG	SANDIK DETAY			TIR			20 LİK KONTEYNER			40 LİK KONTEYNER		
						ÜRÜN ADET	ÜRÜN m²	KG (ÜRÜN+SANDIK)	SANDIK ADET	m²	KG (ÜRÜN+SANDIK)	SANDIK ADET	m²	KG (ÜRÜN+SANDIK)	SANDIK ADET	m²	KG (ÜRÜN+SANDIK)
100x300cm	114x317x40	3MM PLAİN	7	3	180	50	150,00	1.365	19	2.850	25.935	10	1.500	13.650	19	2.850	25.935
		5MM PLAİN	11,66	3	180	35	105,00	1.404	18	1.890	25.277	10	1.050	14.043	18	1.890	25.277
		6MM PLAİN	14	3	180	15	45,00	810	18	810	14.580	10	450	8.100	18	810	14.580
		3MM FIT	8	3	180	45	135,00	1.260	20	2.700	25.200	10	1.350	12.600	19	2.565	23.940
		5MM FIT	12,5	3	180	32	96,00	1.380	19	1.824	26.220	10	960	13.800	18	1.728	24.840
		6MM FIT	15	3	180	26	78,00	1.350	19	1.482	25.650	10	780	13.500	18	1.404	24.300
		3+3 LAMİNEX	15	3	180	26	78,00	1.350	19	1.482	25.650	10	780	13.500	18	1.404	24.300
		5+5 LAMİNEX	25	3	180	16	48,00	1.380	19	912	26.220	10	480	13.800	18	864	24.840
6+6 LAMİNEX	30	3	180	14	42,00	1.440	18	756	25.920	10	420	14.400	18	756	25.920		
100x150 CM	113x163X40	3MM PLAİN	7	1,5	90	50	75,00	615	36	2.700	22.140	30	2.250	18.450	36	2.700	22.140
		5MM PLAİN	11,66	1,5	90	35	52,50	702	36	1.890	25.277	30	1.575	21.065	36	1.890	25.277
		6MM PLAİN	14	1,5	90	30	45,00	720	36	1.620	25.920	30	1.350	21.600	36	1.620	25.920
		3MM FIT	8	1,5	90	45	67,50	630	36	2.430	22.680	30	2.025	18.900	36	2.430	22.680
		5MM FIT	12,5	1,5	90	32	48,00	690	36	1.728	24.840	30	1.440	20.700	36	1.728	24.840
		6MM FIT	15	1,5	90	26	39,00	675	36	1.404	24.300	30	1.170	20.250	36	1.404	24.300
		3+3 LAMİNEX	15	1,5	90	26	39,00	675	36	1.404	24.300	30	1.170	20.250	36	1.404	24.300
		5+5 LAMİNEX	25	1,5	90	16	24,00	690	36	864	24.840	30	720	20.700	36	864	24.840
6+6 LAMİNEX	30	1,5	90	14	21,00	720	36	756	25.920	30	630	21.600	36	756	25.920		
100x100 CM	113x113X40	3MM PLAİN	7	1	60	50	50,00	410	50	2.500	20.500	50	2.500	20.500	50	2.500	20.500
		5MM PLAİN	11,66	1	60	35	35,00	468	50	1.750	23.405	50	1.750	23.405	50	1.750	23.405
		6MM PLAİN	14	1	60	18	18,00	312	50	900	15.600	50	900	15.600	50	900	15.600
		3MM FIT	8	1	60	45	45,00	420	50	2.250	21.000	50	2.250	21.000	50	2.250	21.000
		5MM FIT	12,5	1	60	32	32,00	460	50	1.600	23.000	50	1.600	23.000	50	1.600	23.000
		6MM FIT	15	1	60	26	26,00	450	50	1.300	22.500	50	1.300	22.500	50	1.300	22.500
		3+3 LAMİNEX	15	1	60	26	26,00	450	50	1.300	22.500	50	1.300	22.500	50	1.300	22.500
		5+5 LAMİNEX	25	1	60	16	16,00	460	50	800	23.000	50	800	23.000	50	800	23.000
6+6 LAMİNEX	30	1	60	14	14,00	480	50	700	24.000	50	700	24.000	50	700	24.000		
50x300 CM	114x317X40	3MM PLAİN	7	1,5	180	100	150,00	1.230	19	2.850	23.370	10	1.500	12.300	19	2.850	23.370
		5MM PLAİN	11,66	1,5	180	70	105,00	1.404	18	1.890	25.277	10	1.050	14.043	18	1.890	25.277
		6MM PLAİN	14	1,5	180	60	90,00	1.440	19	1.710	27.360	10	900	14.400	18	1.620	25.920
		3MM FIT	8	1,5	180	90	135,00	1.260	20	2.700	25.200	10	1.350	12.600	19	2.565	23.940
		5MM FIT	12,5	1,5	180	64	96,00	1.380	19	1.824	26.220	10	960	13.800	18	1.728	24.840
		6MM FIT	15	1,5	180	52	78,00	1.350	19	1.482	25.650	10	780	13.500	18	1.404	24.300
		3+3 LAMİNEX	15	1,5	180	52	78,00	1.350	19	1.482	25.650	10	780	13.500	18	1.404	24.300
		5+5 LAMİNEX	25	1,5	180	32	48,00	1.380	19	912	26.220	10	480	13.800	18	864	24.840
6+6 LAMİNEX	30	1,5	180	28	42,00	1.440	19	798	27.360	10	420	14.400	18	756	25.920		
50x150 CM	113x163X40	3MM PLAİN	7	0,75	90	100	75,00	615	36	2.700	22.140	30	2.250	18.450	36	2.700	22.140
		5MM PLAİN	11,66	0,75	90	70	52,50	702	36	1.890	25.277	30	1.575	21.065	36	1.890	25.277
		6MM PLAİN	14	0,75	90	60	45,00	720	36	1.620	25.920	30	1.350	21.600	36	1.620	25.920
		3MM FIT	8	0,75	90	90	67,50	630	36	2.430	22.680	30	2.025	18.900	36	2.430	22.680
		5MM FIT	12,5	0,75	90	64	48,00	690	36	1.728	24.840	30	1.440	20.700	36	1.728	24.840
		6MM FIT	15	0,75	90	52	39,00	675	36	1.404	24.300	30	1.170	20.250	36	1.404	24.300
		3+3 LAMİNEX	15	0,75	90	52	39,00	675	36	1.404	24.300	30	1.170	20.250	36	1.404	24.300
		5+5 LAMİNEX	25	0,75	90	32	24,00	690	36	864	24.840	30	720	20.700	36	864	24.840
6+6 LAMİNEX	30	0,75	90	28	21,00	720	36	756	25.920	30	630	21.600	36	756	25.920		

100*300-120*360 Packaging and Shipping Details

100*300-120*360 Paketleme ve Gönderim Detayı

ÜRÜN EBADI CM	SANDIK EBADI CM	ÜRÜN GRUBU	kg/m²	ADET/m²	BOŞ SANDIK KG	SANDIK DETAY			TİR			20 LİK KONTEYNER			40 LİK KONTEYNER		
						ÜRÜN ADET	ÜRÜN m²	KG (ÜRÜN+SANDIK)	SANDIK ADET	m²	KG (ÜRÜN+SANDIK)	SANDIK ADET	m²	KG (ÜRÜN+SANDIK)	SANDIK ADET	m²	KG (ÜRÜN+SANDIK)
50x100 CM	113x113X40	3MM PLAİN	7	0,5	60	100	50,00	410	50	2.500	20.500	50	2.500	20.500	50	2.500	20.500
		5MM PLAİN	11,66	0,5	60	70	35,00	468	50	1.750	23.405	50	1.750	23.405	50	1.750	23.405
		6MM PLAİN	14	0,5	60	60	30,00	480	50	1.500	24.000	50	1.500	24.000	50	1.500	24.000
		3MM FİT	8	0,5	60	90	45,00	420	50	2.250	21.000	50	2.250	21.000	50	2.250	21.000
		5MM FİT	12,5	0,5	60	64	32,00	460	50	1.600	23.000	50	1.600	23.000	50	1.600	23.000
		6MM FİT	15	0,5	60	52	26,00	450	50	1.300	22.500	50	1.300	22.500	50	1.300	22.500
		3+3 LAMİNEX	15	0,5	60	52	26,00	450	50	1.300	22.500	50	1.300	22.500	50	1.300	22.500
		5+5 LAMİNEX	25	0,5	60	32	16,00	460	50	800	23.000	50	800	23.000	50	800	23.000
6+6 LAMİNEX	30	0,5	60	28	14,00	480	50	700	24.000	50	700	24.000	50	700	24.000		
120x360 CM	134X377x34	3MM PLAİN	7	4,32	220	40	172,80	1.430	15	2.592	21.444	5	864	7.148	15	2.592	21.444
		5MM PLAİN	11,66	4,32	220	27	116,64	1.580	15	1.750	23.700	5	583	7.900	15	1.750	23.700
		6MM PLAİN	14	4,32	220	22	95,04	1.551	15	1.426	23.258	5	475	7.753	15	1.426	23.258
		3MM FİT	8	4,32	220	35	151,20	1.430	15	2.268	21.444	5	756	7.148	15	2.268	21.444
		5MM FİT	12,5	4,32	220	23	99,36	1.462	15	1.490	21.930	5	497	7.310	15	1.490	21.930
		6MM FİT	15	4,32	220	20	86,40	1.516	15	1.296	22.740	5	432	7.580	15	1.296	22.740
		3+3 LAMİNEX	15	4,32	220	20	86,40	1.516	15	1.296	22.740	5	432	7.580	15	1.296	22.740
		5+5 LAMİNEX	25	4,32	220	12	51,84	1.516	15	778	22.740	5	259	7.580	15	778	22.740
6+6 LAMİNEX	30	4,32	220	10	43,20	1.516	15	648	22.740	5	216	7.580	15	648	22.740		
120x180 CM	134x193x34	3MM PLAİN	7	2,16	110	40	86,40	715	30	2.592	21.444	20	1.728	14.296	30	2.592	21.444
		5MM PLAİN	11,66	2,16	110	27	58,32	790	30	1.750	23.700	20	1.166	15.800	30	1.750	23.700
		6MM PLAİN	14	2,16	110	22	47,52	775	30	1.426	23.258	20	950	15.506	30	1.426	23.258
		3MM FİT	8	2,16	110	35	75,60	715	30	2.268	21.444	20	1.512	14.296	30	2.268	21.444
		5MM FİT	12,5	2,16	110	23	49,68	731	30	1.490	21.930	20	994	14.620	30	1.490	21.930
		6MM FİT	15	2,16	110	20	43,20	758	30	1.296	22.740	20	864	15.160	30	1.296	22.740
		3+3 LAMİNEX	15	2,16	110	20	43,20	758	30	1.296	22.740	20	864	15.160	30	1.296	22.740
		5+5 LAMİNEX	25	2,16	110	12	25,92	758	30	778	22.740	20	518	15.160	30	778	22.740
6+6 LAMİNEX	30	2,16	110	10	21,60	758	30	648	22.740	20	432	15.160	30	648	22.740		
120x120 CM	134x134x34	3MM PLAİN	7	1,44	80	40	57,60	483	50	2.880	24.160	20	1.152	9.664	45	2.592	21.744
		5MM PLAİN	11,66	1,44	80	27	38,88	533	50	1.944	26.667	20	778	10.667	45	1.750	24.000
		6MM PLAİN	14	1,44	80	22	31,68	524	50	1.584	26.176	20	634	10.470	45	1.426	23.558
		3MM FİT	8	1,44	80	35	50,40	483	50	2.520	24.160	20	1.008	9.664	45	2.268	21.744
		5MM FİT	12,5	1,44	80	23	33,12	494	50	1.656	24.700	20	662	9.880	45	1.490	22.230
		6MM FİT	15	1,44	80	20	28,80	512	50	1.440	25.600	20	576	10.240	45	1.296	23.040
		3+3 LAMİNEX	15	1,44	80	20	28,80	512	50	1.440	25.600	20	576	10.240	45	1.296	23.040
		5+5 LAMİNEX	25	1,44	80	12	17,28	512	50	864	25.600	20	346	10.240	45	778	23.040
6+6 LAMİNEX	30	1,44	80	10	14,40	512	50	720	25.600	20	288	10.240	45	648	23.040		
60x360 CM	134x377x34	3MM PLAİN	7	2,16	220	80	172,80	1.430	15	2.592	21.444	5	864	7.148	15	2.592	21.444
		5MM PLAİN	11,66	2,16	220	54	116,64	1.580	15	1.750	23.700	5	583	7.900	15	1.750	23.700
		6MM PLAİN	14	2,16	220	44	95,04	1.551	15	1.426	23.258	5	475	7.753	15	1.426	23.258
		3MM FİT	8	2,16	220	70	151,20	1.430	15	2.268	21.444	5	756	7.148	15	2.268	21.444
		5MM FİT	12,5	2,16	220	46	99,36	1.462	15	1.490	21.930	5	497	7.310	15	1.490	21.930
		6MM FİT	15	2,16	220	40	86,40	1.516	15	1.296	22.740	5	432	7.580	15	1.296	22.740
		3+3 LAMİNEX	15	2,16	220	40	86,40	1.516	15	1.296	22.740	5	432	7.580	15	1.296	22.740
		5+5 LAMİNEX	25	2,16	220	24	51,84	1.516	15	778	22.740	5	259	7.580	15	778	22.740
6+6 LAMİNEX	30	2,16	220	20	43,20	1.516	15	648	22.740	5	216	7.580	15	648	22.740		

100*300-120*360 Packaging and Shipping Details

100*300-120*360 Paketleme ve Gönderim Detayı

ÜRÜN EBADI CM	SANDIK EBADI CM	ÜRÜN GRUBU	kg/m ²	ADET/m ²	BOŞ SANDIK KG	SANDIK DETAY			TIR			20 LİK KONTEYNER			40 LİK KONTEYNER		
						ÜRÜN ADET	ÜRÜN m ²	KG (ÜRÜN+SANDIK)	SANDIK ADET	m ²	KG (ÜRÜN+SANDIK)	SANDIK ADET	m ²	KG (ÜRÜN+SANDIK)	SANDIK ADET	m ²	KG (ÜRÜN+SANDIK)
60x180 CM	134x193x34	3MM PLAİN	7	1,08	110	80	86,40	715	30	2.592	21.444	20	1.728	14.296	30	2.592	21.444
		5MM PLAİN	11,66	1,08	110	54	58,32	790	30	1.750	23.700	20	1.166	15.800	30	1.750	23.700
		6MM PLAİN	14	1,08	110	44	47,52	775	30	1.426	23.258	20	950	15.506	30	1.426	23.258
		3MM FİT	8	1,08	110	70	75,60	715	30	2.268	21.444	20	1.512	14.296	30	2.268	21.444
		5MM FİT	12,5	1,08	110	46	49,68	731	30	1.490	21.930	20	994	14.620	30	1.490	21.930
		6MM FİT	15	1,08	110	40	43,20	758	30	1.296	22.740	20	864	15.160	30	1.296	22.740
		3+3 LAMİNEX	15	1,08	110	40	43,20	758	30	1.296	22.740	20	864	15.160	30	1.296	22.740
		5+5 LAMİNEX	25	1,08	110	24	25,92	758	30	778	22.740	20	518	15.160	30	778	22.740
		6+6 LAMİNEX	30	1,08	110	20	21,60	758	30	648	22.740	20	432	15.160	30	648	22.740
60x120 CM	134x134x34	3MM PLAİN	7	0,72	80	80	57,60	483	50	2.880	24.160	20	1.152	9.664	45	2.592	21.744
		5MM PLAİN	11,66	0,72	80	54	38,88	533	50	1.944	26.667	20	778	10.667	45	1.750	24.000
		6MM PLAİN	14	0,72	80	44	31,68	524	50	1.584	26.176	20	634	10.470	45	1.426	23.558
		3MM FİT	8	0,72	80	70	50,40	483	50	2.520	24.160	20	1.008	9.664	45	2.268	21.744
		5MM FİT	12,5	0,72	80	66	47,52	674	50	1.656	24.700	20	662	9.880	45	1.490	22.230
		6MM FİT	15	0,72	80	40	28,80	512	50	1.440	25.600	20	576	10.240	45	1.296	23.040
		3+3 LAMİNEX	15	0,72	80	40	28,80	512	50	1.440	25.600	20	576	10.240	45	1.296	23.040
		5+5 LAMİNEX	25	0,72	80	24	17,28	512	50	864	25.600	20	346	10.240	45	778	23.040
		6+6 LAMİNEX	30	0,72	80	20	14,40	512	50	720	25.600	20	288	10.240	45	648	23.040

Packaging and Shipping Details

Paketleme ve Gönderim Detayları

Packaging And Packages

Ambalaj ve Paketler

Kalesinterflex 6mm, 12mm, and 20mm thick full-length 1620x3230 mm slabs are vertically packed on metal "A-Frame".

Kalesinterflex 6mm, 12mm ve 20mm tam boy 1620x3230 mm plakalar, metal "A Frame" üzerinde dikey olarak ambalajlanır.

A-Frame

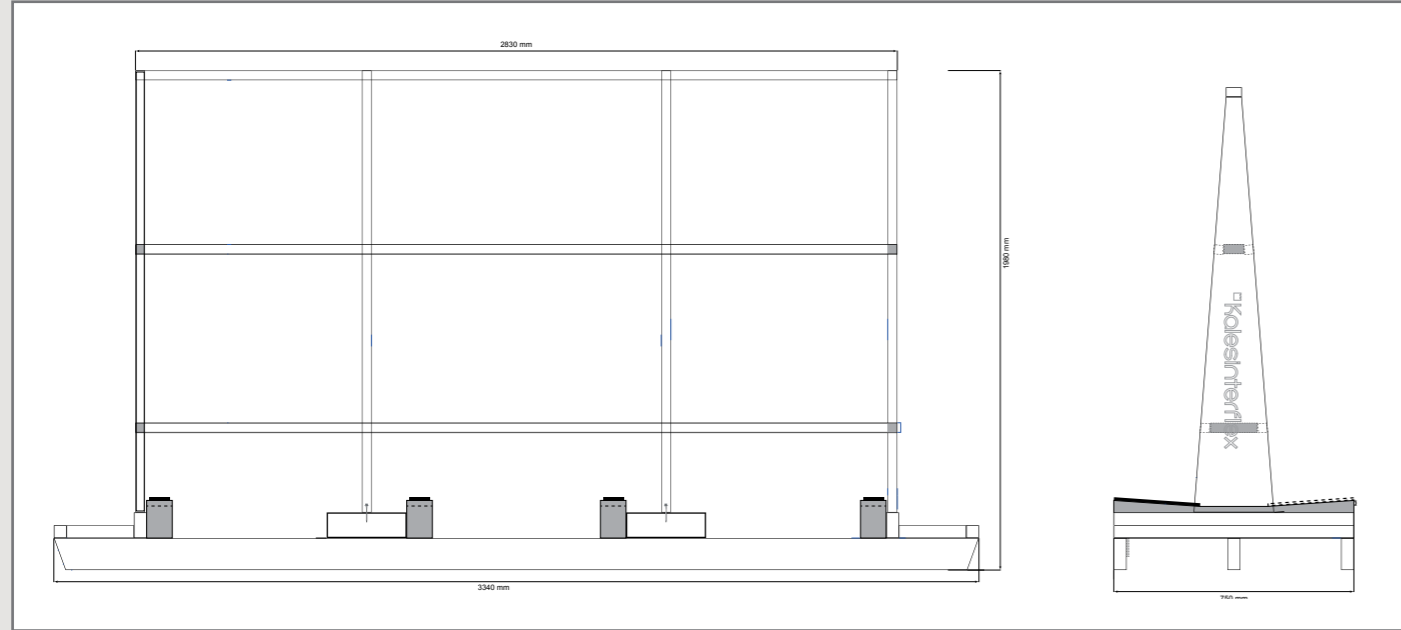

162x323 cm Quantity, Weight and Size Information of A-Frame;

162x323 cm A-Frame Metraj, Kilogram ve Ölçü Bilgileri;

Format/mm (vertical stacking)	Thickness Kalınlık (mm)	Pcs for A-Frame (Pcs/A-Frame) A-Frame için adet (Adet/A-frame)	m ² for A-Frame A-Frame için m ²	Weight (kg) for A-Frame (A-frame is included.)	Full Size of A-Frame (cm)
Kalesinterflex 6 mm Full Length* Tam Boy* 1620x3230 mm 63.7"x127.7"	6	44	230.12	3420	334x75x198h
Kalesinterflex 12 mm Full Length* Tam Boy* 1620x3230 mm 63.7"x127.7"	12	24	125.52	3782	334x75x198h
Kalesinterflex 20 mm Full Length* Tam Boy* 1620x3230 mm 63.7"x127.7"	20	12	62.76	3173	334x75x198h

*"Furnace Slab" having untrimmed format. 5,23 m²/piece-Empty A-Frame 130kg (metal)

* Tıraşlanmamış "fırın çıkışı" formatı plaka. 5.23m²/adet - Boş A-Frame 130kg (metal)

160x320 cm Quantity, Weight and Size Information of A-Frame;

160x320 cm A-Frame Metraj, Kilogram ve Ölçü Bilgileri;

Format/mm (vertical stacking)	Thickness Kalınlık (mm)	Pcs for A-Frame (Pcs/A-Frame) A-Frame için adet (Adet/A-frame)	m ² for A-Frame A-Frame için m ²	Weight (kg) for A-Frame (A-frame is included.)	Full Size of A-Frame (cm)
Kalesinterflex 6 mm Full Length* Tam Boy* 1600x3200 mm 63.0"x126.0"	6	44	225.28	3348	334x75x198h
Kalesinterflex 12 mm Full Length* Tam Boy* 1600x3200 mm 63.0"x126.0"	12	24	122.88	3703	334x75x198h
Kalesinterflex 20 mm Full Length* Tam Boy* 1600x3200 mm 63.0"x126.0"	20	12	61.44	3108	334x75x198h

162x323 cm Information Regarding the A-Frame Carrying Capacities of Containers and Trucks

162x323 cm Konteyner ve Tır A-Frame Kapasite Bilgileri

Container Loading with A-frame / A-Frame Konteyner Yükleme (1620x3230 mm (63.7"x127.7"))									
Container Type Konteyner Tipi	20" Container Konteyner			40" Container Konteyner			Truck / Tır (13.60m)		
The Thickness of the Slab Slab Kalınlık (mm)	6	12	20	6	12	20	6	12	20
A-Frame That Can Be Loaded (Pieces) Yüklenebilir A-Frame (Adet)	3	3	3	7	7	7	7	7	7
Slabs That Can Be Loaded (Pcs) Yüklenebilir Slab (Adet)	132	72	36	308	168	84	308	168	84
Loadable Area Yüklenebilir (m ²)	690.36	376.56	188.28	1610.84	878.64	439.32	1610.84	878.64	439.32
Maximum Total Weight Azami toplam ağırlık (kg)	10.260	11.346	9.519	23.940	26.474	22.212	23.940	26.474	22.212

* Empty weight of A-Frame 121kg (metal)

* Bos A-Frame ağırlığı 130kg (metal)

160x320 cm Information Regarding the A-Frame Carrying Capacities of Containers and Trucks

160x320 cm Konteyner ve Tır A-Frame Kapasite Bilgileri

Container Loading with A-frame / A-Frame Konteyner Yükleme (1600x3200 mm (63.0"x126.0"))									
Container Type Konteyner Tipi	20" Container Konteyner			40" Container Konteyner			Truck / Tır (13.60m)		
The Thickness of the Slab Slab Kalınlık (mm)	6	12	20	6	12	20	6	12	20
A-Frame That Can Be Loaded (Pieces) Yüklenebilir A-Frame (Adet)	3	3	3	7	7	7	7	7	7
Slabs That Can Be Loaded (Pcs) Yüklenebilir Slab (Adet)	132	72	36	308	168	84	308	168	84
Loadable Area Yüklenebilir (m ²)	675.84	368.64	184.32	1576.96	860.16	430.08	1576.96	860.16	430.08
Maximum Total Weight Azami toplam ağırlık (kg)	10.044	11.109	9.324	23.436	25.921	21.756	23.436	25.921	21.756

1. Carrying and Storing

1. Taşıma ve Depolama

Kalesinterflex 1620x3230mm slabs should be carried in safe conditions to protect their original appearance and prevent accidental damage. It is recommended to be careful and make sure that the carrying area is closed to pedestrians while the product is carried.

Kalesinterflex 1620x3230mm plakaların taşınması, malzemenin orijinal görünümünü korumak ve kazara kırılmalarını önlemek için güvenli koşullarda gerçekleştirilmelidir. Malzemenin taşınması aşamalarında, alanın yayalara kapalı olduğundan emin olarak dikkat gösterilmesi tavsiye edilir.

1.1. Carrying A-Frame with a Forklift

1.1. Forklift ile A-Frame Taşıma

A-Frame should be symmetrically loaded before carrying to prevent balance problems. Before carrying, the operator should always check that the slabs are fixed to A-Frame with special tapes. It is recommended to be careful while carrying the slabs loaded on the A-Frame since they are not protected at the points corresponding to the outer edges.

A-Frames are equipped with two gripping points to be carried with a forklift:

The distance between the forklift's forks for "A" front gripping point is 740 mm. The distance between the forks for the "B" lateral gripping point is 500mm.

If both A and B lateral loading points are to be used, a forklift that has 8000 kg. maximum load capacity is recommended. The Kalesinterflex porcelain slabs loaded on the A-Frame in the warehouse or near the transformer should be preferably carried by using the "A" front gripping point. In other words, the process should be carried out by using a 3230 mm A-Frame, to which the products are to be fixed, and a forklift that has 1200 mm long forks at least, and a 5000-8000 kg load capacity. If the 'B' gripping point is to be used, a forklift that has an 8000 kg load capacity and at least 2800 mm forks should be used. It should be ensured that the load does not move on the forks. While loading and unloading trucks and containers, fix A-Frame with the help of the two "A" and "B" gripping points in the way specified in the following paragraphs, respectively. While loading/unloading the trucks and containers and carrying even a single slab, fix the slabs to A-Frame with cloth or plastic tapes/straps. Metal chains should not be used at this stage.

Before the slabs are taken out from the A-Frame, it is necessary to place it on a flat surface having no defects that may cause the slab (s) to fall.

Taşımadan önce, dengesizlik problemlerini önlemek için A-Frame simetrik olarak yüklenmelidir. Operatör taşımaya geçmeden önce, plakaların özel bantlarla A-Frame sabitlenmiş olduklarını daima kontrol etmelidir. A-Frame üzerine yüklenen plakalar dış kenarlara karşılık gelen noktalarda korunmadığından, malzemeyi taşıma aşamaları esnasında dikkatli olunması önerilir.

A-Frameler forklift ile taşıma için iki kavrama noktası ile donatılmıştır:

"A" ön kavrama noktası; En az 740 mm forklift bıçak aralığı mesafesi. "B" yanal kavrama noktası bıçak aralığı mesafesi 500mm'dir.

Eğer A ve B yan al yükleme noktalarından her ikisi de kullanılacak ise max. 8000 kg kapasiteli forklift tercih edilmesi önerilir. Depodaki veya transformatör yakınındaki A-Frame üzerine yüklenmiş Kalesinterflex porselen plakaların taşınması, tercihen ön kavrama noktası "A" kullanılarak, yani A-Frame 3230mm tarafından en az 1200 mm uzunluğunda çatallar ve en az 5000-8000 Kg kapasiteye sahip bir forklift kullanmak suretiyle sabitleyerek gerçekleştirilmelidir. Kavrama noktası 'B' kullanılıyorsa, en az 2800 mm uzunluğunda çatallara sahip 8000 Kg kapasiteli bir forklift kullanılmalıdır.

Yükün çatallar üzerinde sabit durduğundan ve sallanmadığından emin olunmalıdır. Kamyonlardan ve konteynerlerden yükleme ve boşaltma aşamalarında, sırasıyla aşağıdaki paragraflarda belirtilen "A" ve "B" iki kavrama noktası yardımıyla A-Frame sabitleyin. Yüklerken/boşaltırken ve ardından tek bir plakayı bile taşıırken, bez veya plastik bantlar/kayışlar kullanarak plakayı A-Frame sabitleyin. Bu aşamada metal zincirler kullanılmamalıdır.

Plakalar A-Frame sabitleyen bantlardan serbest bırakılmadan önce, A-Frame, plakanın/plakaların düşmesine neden olabilecek zemin seviye farklılıklarının olmadığı düz bir yüzeye yerleştirildiğinden emin olunması gerekmektedir.

Forklift with 5000 weight (kg)
capacity to carry from direction B

*A yönünden taşıma için 5000kg
kapasiteli forklift*

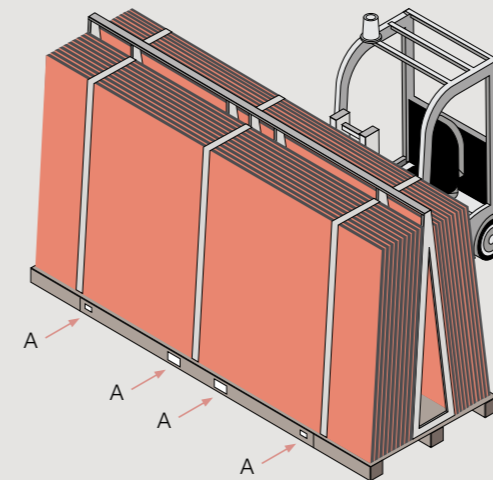

Forklift with 8000 weight (kg)
capacity to carry from direction A

*B yönünden taşıma için 8000kg
kapasiteli forklift*

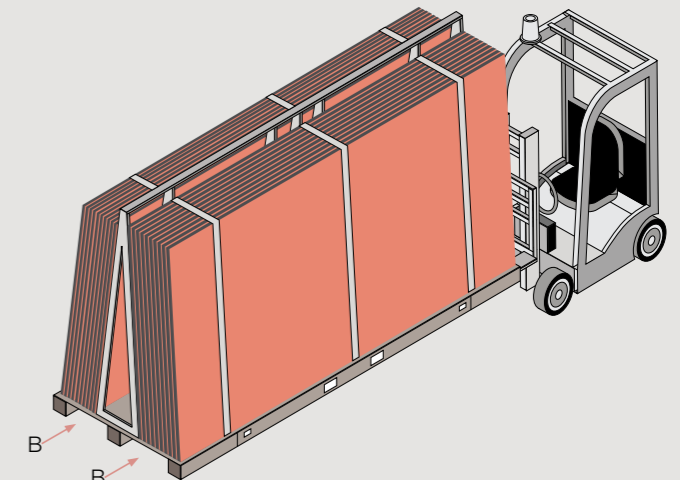

1.1.1. Loading/Unloading the Truck with A-frame

1.1.1. Kamyon Üzerine A-frame Yükleme/Boşaltma

To load and unload the trucks which have dropside bodies, fix the A-Frame by placing the forklift forks at two "A" gripping points and leaving at least a distance of 740 mm between them. Forklift forks with a minimum length of 1200 mm should be used to place the A-Frame in the middle of the truck.

To safely carry the products on the vehicles, fix the A-Frames to the truck bed from the base and top. Use polyester or similar straps for this work. If you load several rows of A-Frames, you should leave a distance of at least 50 mm between them.

During loading and unloading, the operator should be careful about the people around. A-Frame should always be kept low while being carried and only be lifted when it is very close to the truck. You will find below an example of loading an A-Frame on a truck with a standard length of 13.60 m.

Wooden boards having at least 7x9 cm sizes, which are placed in the forklift lifting slots, are used to bolster the A-frames.

Kenarları açılan kamyonlara yüklemek ve boşaltmak için, forklift çatallarını en az 740 mm forklift bıçak açıklığı olacak şekilde iki kavrama noktasına "A" yerleştirerek A-Frame'i sabitleyin. A-Frame kamyonun merkezi konumuna yerleştirmek için minimum 1200 mm uzunluğa sahip forklift çatallar kullanılması gerekmektedir.

Araçlar üzerinde güvenli taşıma için, A-Frameleri kamyon kasasına hem tabandan hem de yapının üst kısmından sabitleyin. Bu amaçla polyester veya benzeri kayışlar kullanın. Birkaç sıra A-Frame yüklerken arasında en az 50 mm mesafe bırakın.

Yükleme ve boşaltma sırasında operatör çevredeki insanlara dikkat edilmelidir. A-Frame yük taşıma sırasında her zaman alçak tutulmalı ve yalnızca kamyonu çok yakın iken yukarı kaldırılmalıdır. Aşağıda 13,60 m standart uzunluktaki bir kamyon için bir A-Frame yükleme örneği gösterilmiştir

A-Frameleri desteklemek için forkliftin taşıma yuvalarından geçen en az 7x9cm kesitli latalar kullanılır.

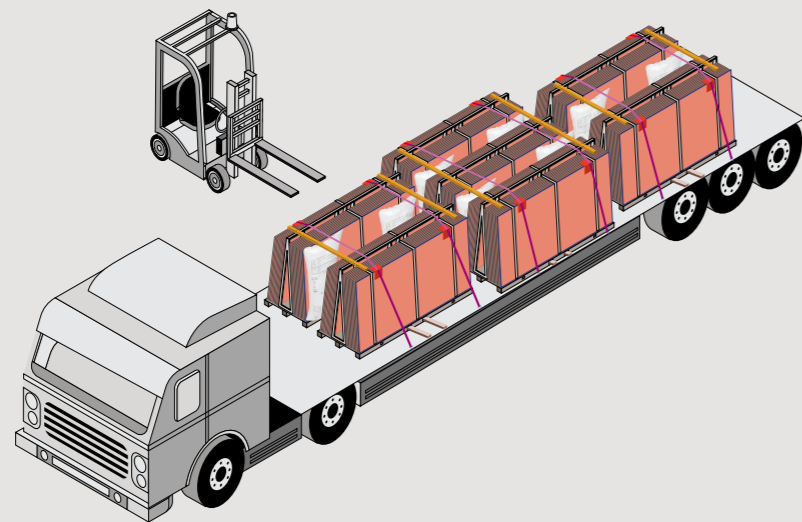

1.1.2. Domestic and International Highway Transportation with Truck Highway Transportation

1.1.2. Yurt içi ve Yurt dışı Karayolu Kamyon Taşıma

In international transportation with trucks, two A-Frames are fixed to the vehicle chassis with at least two safety ropes. Airbag or styrofoam is used as abolster between the two A-Frames.

Yurtdışı Kamyon ile taşımada, iki A-Frame en az 2 spanzet ile araç şasisine bağlanır ki A-Frame arasında destek olarak hava yastığı veya strafor kullanılır.

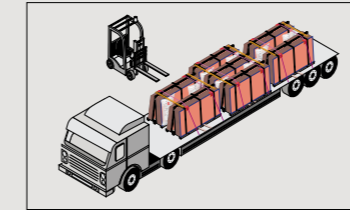
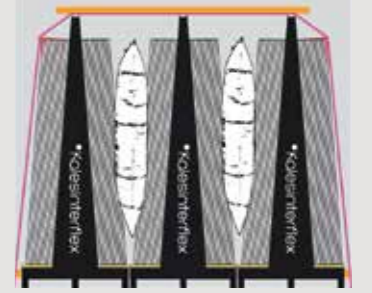

Domestic and international highway transportation with trucks.

Yurt içi ve yurt dışı karayolu kamyon taşıma.



Domestic and international highway transportation with trucks.

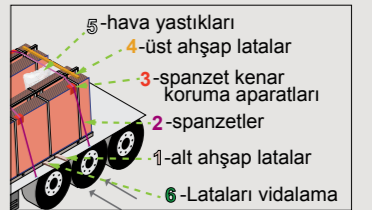

Domestic and international highway transportation with trucks.

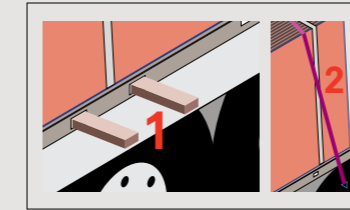

1- To support one or three A-Frames in a row, two wooden boards, which have at least 7x9 cm cross-sections and 240cm lengths, are used and placed in the forklift lifting slots.

2- A-Frames are fixed to the trailer with at least two safety ropes that will pass through the top profile of the frames. **The safety ropes should not be over-tightened.**

1- Bir sıradaki 1 veya 3 A-Frameleri desteklemek için, forkliftin taşıma yuvalarından geçen, 2 adet en az 7x9cm kesitli 240cm boyunda latalar kullanılır. 2- A-Framelerin en üst profilinden geçecek, en az 2 adet spanzet ile dorseye bağlanır. **Spanzetin aşırı sıkılmamasına dikkat edilmeli.**

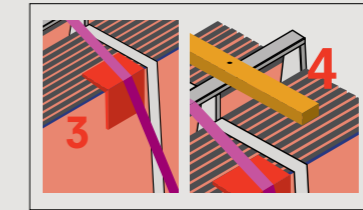

3- Protective plastic supports are placed on the edges where the safety ropes touch the slab.

4- The two or three A-Frames in a row are screwed to the wooden boards from their upper profiles and thus, their movement is restricted.

3- Spanzetlerin slab ürüne temas ettiği kenarlara koruyucu plastik destekler konur.

4- Bir sıradaki 2 veya 3 A-Frameler, vida yardımı ile üst profillerinden latalarla birleştirilerek hareket etmeleri kısıtlanır.

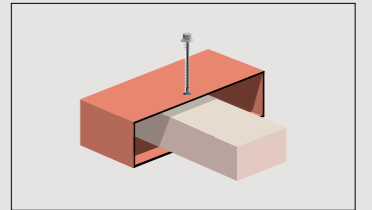

Wooden boards are screwed from the slots where the forklift forks are inserted. Two or three A-Frames are fixed by screwing the wooden boards, which have been passed through the Frames, to the outward-facing sides of the truck trailer. If there is no screw hole on the A-Frame, it is fixed with 5.5x90 DIN7504k, Hexagon drill-tip trapeze-panel screws with EPDM Rubber Washer.

Forklift bıçaklarının girdiği yuvalardan latalar vidalama yapılır ki veya üç A-Frame, içinden geçirilen latalar kamyon kasasında dışa bakan taraflardan vidalanarak sabitlenir. A-Frame'de hazır vida deliği yok ise 5,5x90 DIN7504k Altı köşe, Epdm Pullu, matkap uçlu trapez-panel vidaları ile sabitlenir.

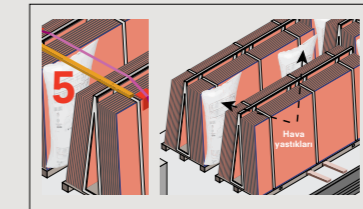

5- Two airbags are vertically placed between the A-Frames in each row.

5- Her sıradaki A-Framelerin arasında ikişer adet dikey şekilde hava yastığı konur.

1.1.3. Loading/Unloading Container with A-Frame

1.1.3. Konteyner üzerine A-Frame Yükleme/Boşaltma

Use a pallet jack or forklift with a 8000 kg load capacity and forks of at least 2800 mm while the products are loaded on the container, and the container is unloaded. The operator moves the loaded A-Frame after taking and lifting the load with the help of the two "B" gripping points.

During loading, check the balance of the product by fixing the A-Frames to each other and the towing platform. To carry the frames safely on the container, fill the gaps between the sca olds and between the sca old rows and airbags.

Before the unloading, always check the methods used while locking the A-Frames, to remove the locks.

Outside the container, carry the product by attaching the A-Frames to the "A" gripping point every time.

Konteyner içine malzemenin yüklenmesi ve boşaltılması aşamalarında bir transpalet veya minimum 2800 mm uzunluğunda çatallar ile donatılmış 8000 kg kapasiteli bir forklift kullanın. Operatör, iki kavrama noktası "B" yardımıyla yükü alarak ve kaldırarak dolu A-Frame hareket ettirir.

Yükleme sırasında, A-Frameleri birbirine ve çekme platformuna bağlayarak ve sabitleyerek malzemenin doğru dengesini kontrol edin. Konteyner üzerinde güvenli taşıma için, iskeleler arasındaki ve iskele sıraları arasındaki boşlukları hava yastıklarıyla doldurun.

Boşaltma aşamasından önce, kilitlerin etkili bir şekilde çıkarılmasını sağlamak için, daima A-Framelerin kilitledikleri yöntemi kontrol edin. Konteyner dışında, malzemeyi daima A-Frameleri "A" kavrama noktasına tutturarak taşıyın.

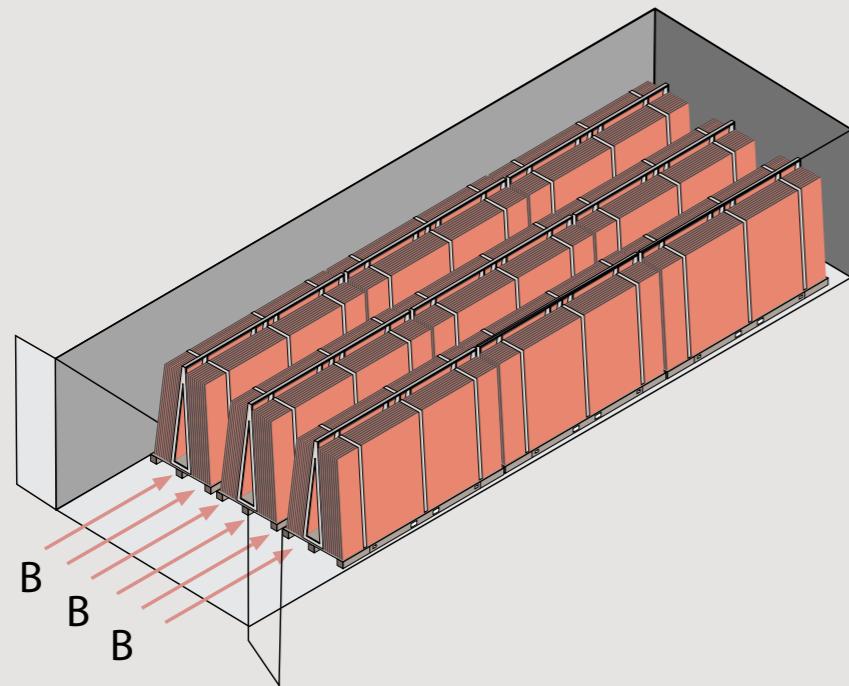

For loading/unloading the slabs, as seen in the picture below, a special lifting tool with belts, which is installed on a forklift having a load capacity of 5000-8000 kg. should be used. On the other hand, a crane equipped with a lifting arm, which is usually used to carry slabs, can be utilized.

Bu Plaka yüklenmesi/boşaltılması için, forklifte uygulanmış aşağıdaki resimdeki gibi vakumlu özel bir kaldırma ekipmanı veya alternatif olarak genellikle slab plakaları taşımak için kullanılan kaldırma kolu ile donatılmış bir vinç kullanılmalıdır.



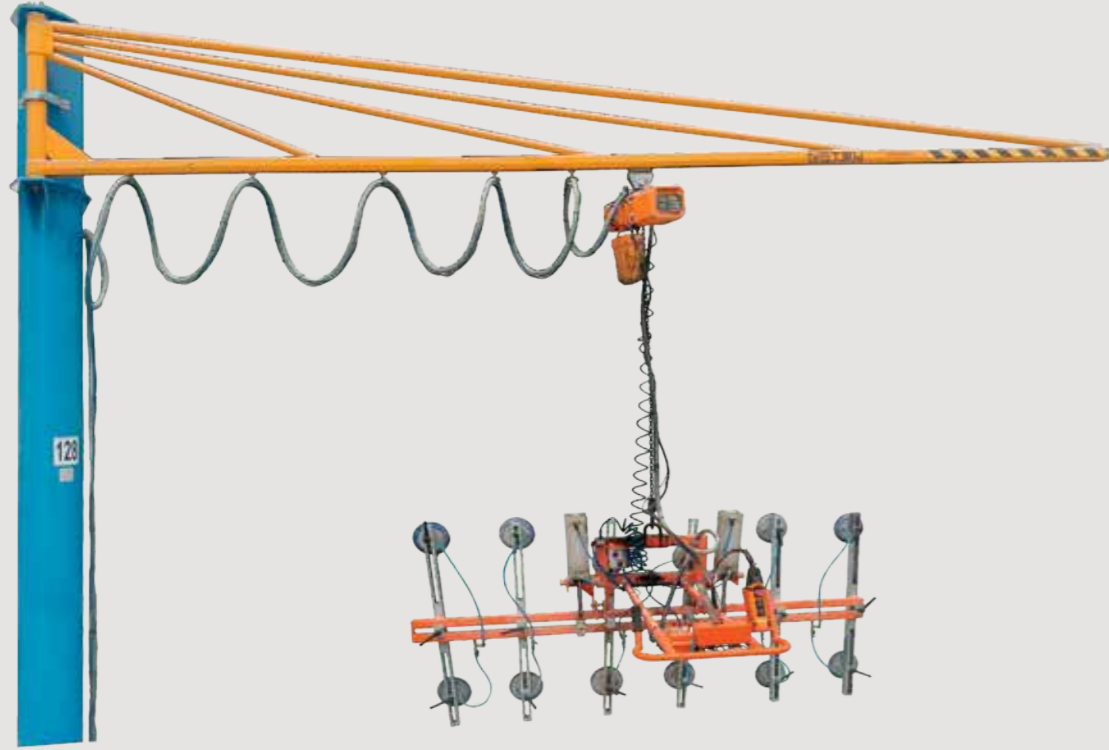

We recommend you use a similar tool and follow the same method to prevent imbalance and accidental damage during the unloading period.

Regardless of the method used for storing, other materials should not be put on Kalesinterflex porcelain slabs, especially on glossy surfaces.

If it is necessary to put them on top of each other, there should be no contact between the slabs. If the products are to be transferred from A-Frame to A-Frame one by one, precautions should be taken against surface damage that may occur.

Boşaltırken dengesizliği ve kazayla kırılmayı önlemek için benzer bir alet kullanmanızı ve aynı çalışma yöntemini takip etmenizi öneririz.

Depolama için kullanılan yöntem ne olursa olsun, Kalesinterflex porselen plakalar üzerine, özellikle parlak yüzeyler üzerine başka malzemelerin üst üste konmamasıdır.

Üst üste koymak gerekiyorsa, plakaların aralarından temas kesilmelidir. Ürünleri tekil olarak A-Frame den A-Frame aktarılırken oluşabilecek yüzey hasarlanmalarına karşı önlem alınmalıdır

1.1.4.Safety Criteria

1.1.4.Güvenlik Kriterleri

Instruction for Slab Loading/Unloading/Transportation

Porselen Plaka Yükleme/Boşaltma/Taşıma Talimatı

DİKKAT! ATTENTION!

Konteyner ve Tır/Kamyon yükleme ve boşaltma içindir.
Container and truck for loading and unloading.

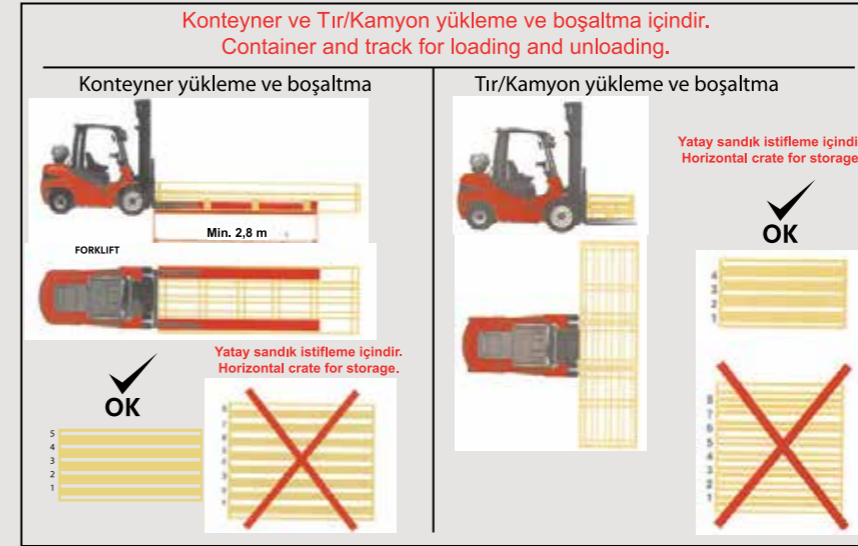

DİKKAT! ATTENTION!

Konteyner ve Tır/Kamyon yükleme ve boşaltma içindir.
For container and truck loading and unloading

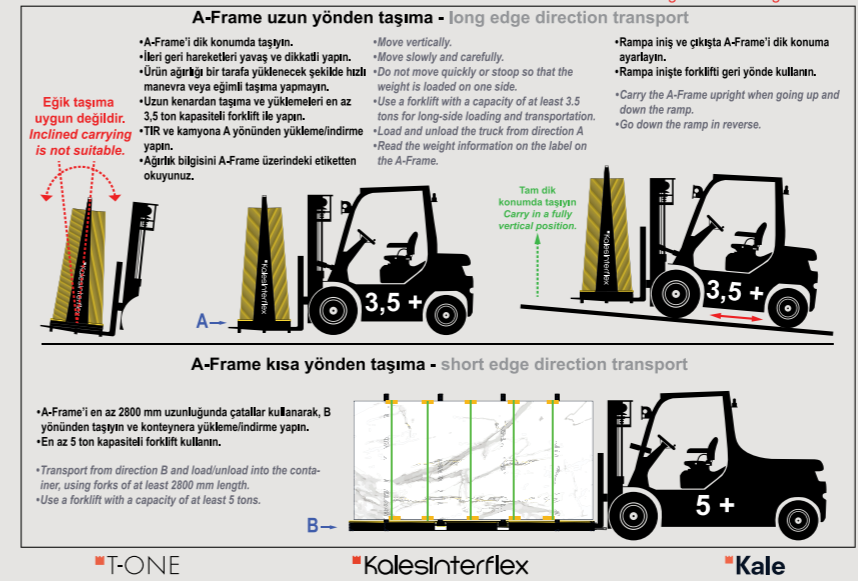

T-ONE

Kalesinterflex

Kale

Kalesinterflex® AHŞAP YATAY AMBALAJ SANDIĞI AÇMA, BOŞALTIMA VE ÜRÜN TAŞIMA TALİMATI

INSTRUCTION FOR OPENNING, UNLOADING AND HANDLING THE Kalesinterflex® HORIZONTAL WOODEN CASE

1. YATAY SANDIĞIN SADECE ÜST KAPAĞINI AÇIN. Kalesinterflex® İNCE KENARININ ÜZERİNE KALDIRIP (Şekil 1), VAKUMLU TAŞIMA APARATI İLE VEYA YERE DİK TUTARAK SPANZET İLE TAŞIYIN. İNSAN GÜCÜ İLE TAŞIMA İÇİN EN AZ 5 KİŞİ EL VAKUMLU APARATLARI İLE YERE DİK OLARAK TAŞIMALIDIR.
2. Kalesinterflex® İ KESİNLİKLE YERE PARALEL ESNETEREK TAŞIMAYINIZ.
3. YATAY SANDIĞIN YAN TAHTALARINI AÇARAK BOŞALTIMA KESİNLİKLE YAPMAYINIZ.
4. DOĞRU TAŞIMA YÖNTEMİ OLARAK AYRICA Kalesinterflex® İN YERE DİK TUTULARAK VANTUZ İLE 5 KİŞİ TARAFINDAN TAŞINMASI TAVSİYE EDİLİR.

1. OPEN ONLY THE TOP COVER OF THE HORIZONTAL CASE. LIFT Kalesinterflex® ON ITS THIN SIDE (Figure 1). CARRY IT WITH THE VACUUM CARRYING APPARATUS OR KEEP IT VERTICAL TO THE FLOOR WITH A SPANZET. FOR HANDLING WITH PEOPLE, AT LEAST 5 PEOPLE SHOULD CARRY IT UP TO THE GROUND WITH HAND VACUUM APPARATUS.
2. PLEASE DO NOT BEND THE SLAB IN A PARALLEL POSITION TO GROUND.
3. PLEASE DO NOT UNPACK THE PRODUCT BY REMOVING THE SIDE WALLS OF THE CASE.
4. FOR PROPER HANDLING, IT IS RECOMMENDED TO HOLD THE Kalesinterflex® VERTICALLY AND HANDLE THE SLABS WITH SUCTION CUPS BY TWO STAFF.

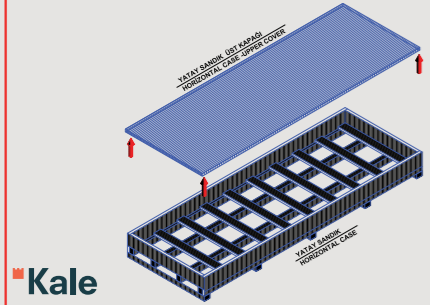

Kale

TAŞIMA ÖNERİLERİ CARRYING RECOMMENDED

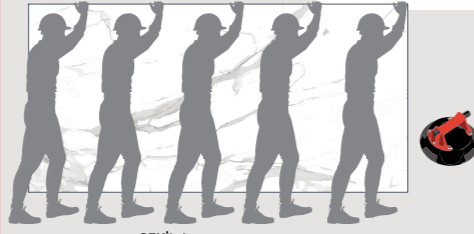

ŞEKİL 1
FIGURE 1

Kalesinterflex®

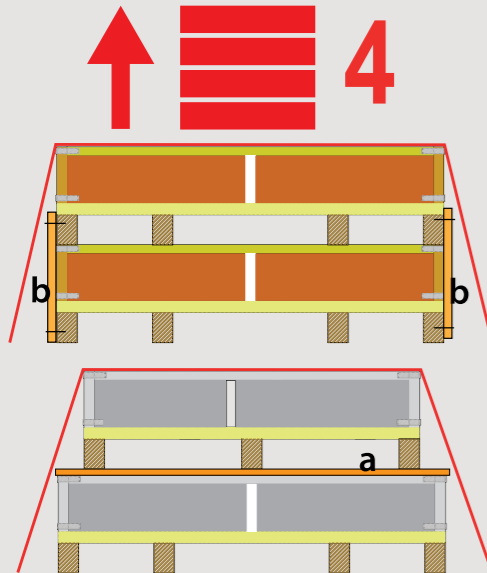

KALESİTERFLEX SANDIKLARININ YÜKLEME TALİMATI

LOADING INSTRUCTION FOR KALESİTERFLEX CHESTS

Aynı ebata sahip en fazla 4 sandık üstü üste istiflenebilir. Aynı boyuttaki sandıklar ayakları her yönden bir biri üzerine hizalanacak şekilde dizilir. Ayaklar, kapağın destek-siz kısımlarına basmamalıdır. Sandıklar ayaklarından birbirine lata (b) ile vidalanarak sabitlenir.

Farklı boyutlarda sandıklar dizilirken küçük ve hafif olan büyük ve ağır olan üzerine konulur. Sandıklar arasında destek malzemeler (lata/kalas) (a) konulur ve kaymayı önlemek için ayaklardan lata (b) ile vidalanarak sabitlenir.

Tüm sandıklar spanzet ile kamyon kasasına veya konteynra bağlanarak sabitlenir.

A maximum of 4 crates of the same size can be stacked on top of each other. Crates of the same size are arranged so that their legs are aligned on top of each other from all directions. Feet should not step on unsupported parts of the cover. The crates are fixed to each other by screwing their legs with laths (b). While crates of different sizes are arranged, the small and light ones are placed on top of the large and heavy ones. The legs are aligned on at least two edges, support materials (laths/planks) (a) are placed between the crates and the legs are fixed by screwing with laths (b) to prevent slipping. All crates are fixed to the truck or container with spanners.

Kale Kalesinterflex

Instruction for Empty A-Frame Loading

Boş A-Frame Yükleme Talimatı

DİKKAT! ATTENTION!

Tır/Kamyon ile A-Frame taşıma içindir.
For A-Frame transportation by truck/TIR

Boş A-Frame taşıma talimatı - Empty A-Frame transport instructions

Matters to be considered in the loading instruction:

- Empty A-Frames should be loaded with a forklift from the side.
- There should be two people on the trailer for support during the loading.
- The first A-Frame in the figure is loaded first. The second A-frame is carried by the forklift and placed on the third A-frame with the support of the two people.
- The fourth A-frame is placed on the third A-frame and the wedge, as shown in the image, with the support of the two people.
- Each loaded A-Frame is tied and fixed with a safety rope or steel rope.

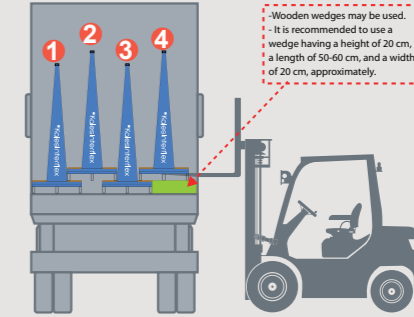

Wooden wedges may be used.
It is recommended to use a wedge having a height of 20 cm, a length of 50-60 cm, and a width of 20 cm, approximately.

Loading horizontally a total of 16 pieces of 75x335x198cm A-Frames on the truck, in a row of 4x4, in 4 groups, each containing four frames

125kg x 16 = 2000kg (approximate tonnage)

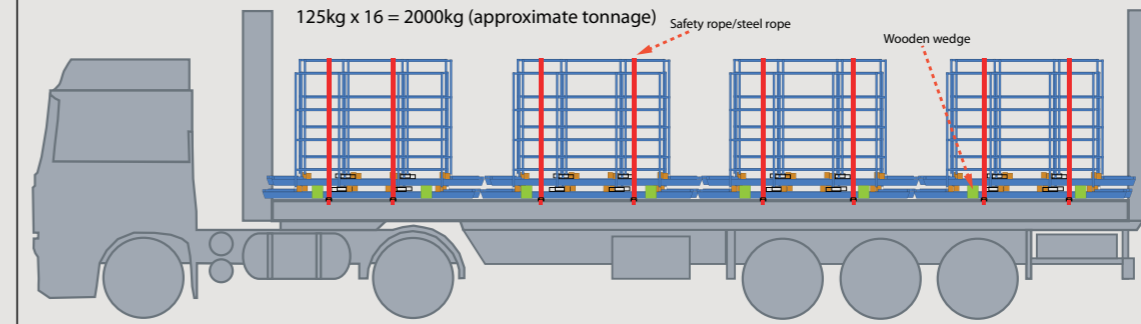

T-ONE

Kalesinterflex

Kale

1. Loading Instruction for Kalesinterflex Chests

1. Kalesinterflex Sandıklarının Yükleme Talimatı

- Up to 4 crates of the same size may be stacked on top of one another.
- Crates of the same size are lined by enabling their feet to overlap on top of one another from all directions. The feet should come across the unsupported parts of the cover. Crates are fixed to each other by screwing their feet to the wooden board (b).
- When lining up crates of different sizes, the small and light ones are placed on the large and heavy ones. Supporting materials (wooden board/plank) (a) are placed between the crates and **the feet of the crates are fixed by screwing them to the wooden board (b) to prevent slipping.**
- All crates are fixed by fastening them to the truck trailer or container with a safety rope.

- Aynı ebata sahip en fazla 4 sandık üst üste istiflenebilir.
- Aynı boyuttaki sandıklar ayakları her yönden bir biri üzerine hizalanacak şekilde dizilir. Ayaklar, kapağın desteksiz kısımlarına basmalıdır. Sandıklar ayaklarından birbirine lata (b) ile vidalanarak sabitlenir.
- Farklı boyutlarda sandıklar dizilirken küçük ve hafif olan büyük ve ağır olan üzerine konulur. Sandıklar arasına destek malzemeler (lata/kalas) (a) konulur ve **kaymayı önlemek için ayaklardan lata (b) ile vidalanarak sabitlenir.**
- Tüm sandıklar spanzet ile kamyon kasasına veya konteynıra bağlanarak sabitlenir.

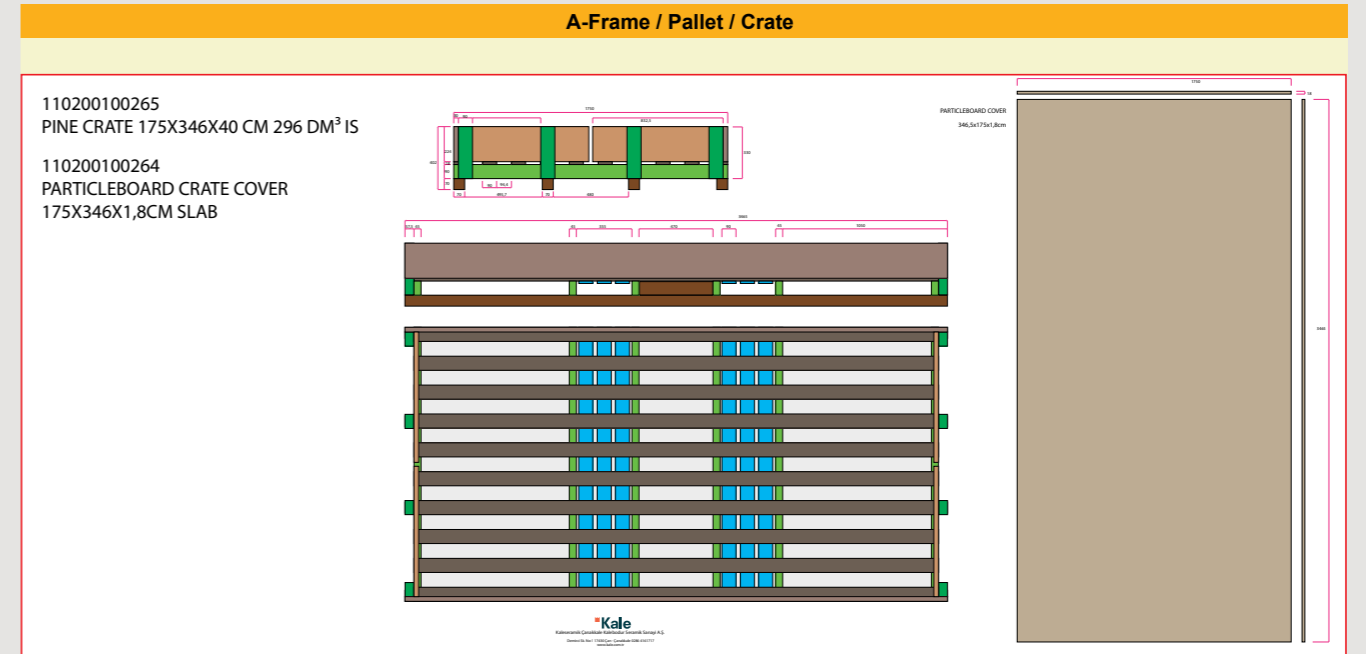
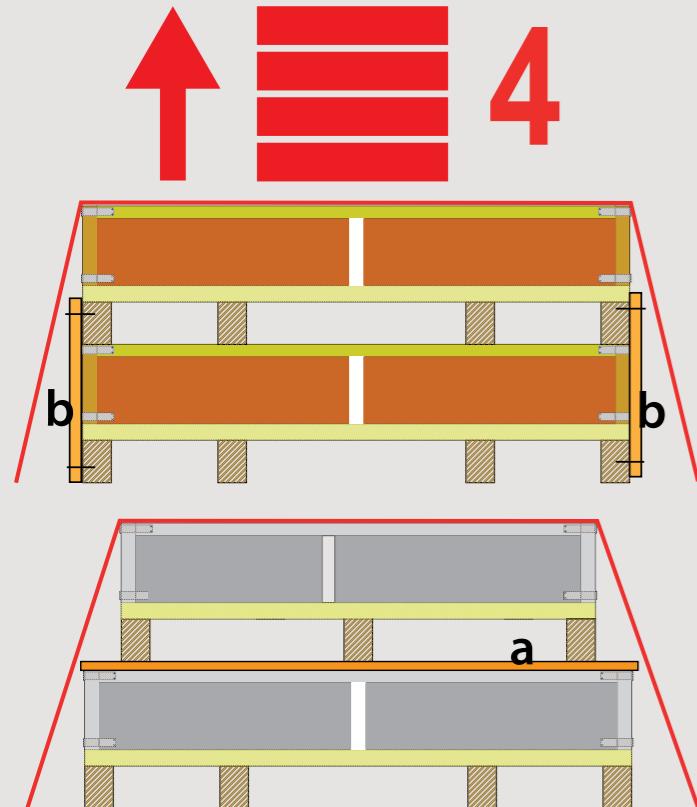

110200100265
PINE CRATE 175X346X40 CM 296 DM³ IS
110200100264
PARTICLEBOARD CRATE COVER
175X346X1,8CM SLAB

Product Index of Packaging Materials

110200100265	PINE CRATE 175X346X40 CM 296 DM ³ IS	1 piece
110200100264	PARTICLEBOARD CRATE COVER 175X346X1,8CM SLAB	1 piece
110200600050	STYROFOAM 60x100x2cm	18 pieces-to bottom and uppermost
110400100220	INSTRUCTION FOR SLAB-LOADING, UNLOADING AND CARRYING A&B	1 set (2 piece)
110200400134	LABEL 20X15CM 160X320 6-6,5MM 14A BX	2 piece
100200300086	STRETCH HOOD 2900-550-550 MM BX	1 piece

Unit Quantity Definitions

	Piece	Piece/Crate	40" Container
Piece	1	14	15
m2	5,120	71,680	1075,2
Weight (kg)	73	1222	18330
Size	160x320		
Thickness	6-6,5 mm		
Row/Layer		14	

Labels and Marking / Tying

Part Label / Marking



100x150mm parça etiketi

A-Frame/ Pallet / Crate Label



Pallet label 150x100mm

Instructions to be attached to the crate
110400100220 INSTRUCTION FOR SLAB-LOADING,
UNLOADING AND CARRYING A&B

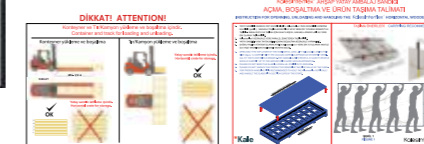

Tying

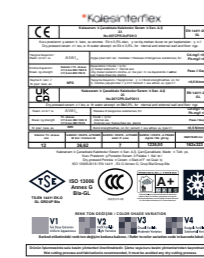

110200400134
LABEL 20X15CM 160X320 6-6,5MM 14A BX

A-Frame / Pallet / Crate

110200100265
PINE CRATE 175X346X40 CM 296 DM³ IS

110200100264
PARTICLEBOARD CRATE COVER
175X346X1,8CM SLAB

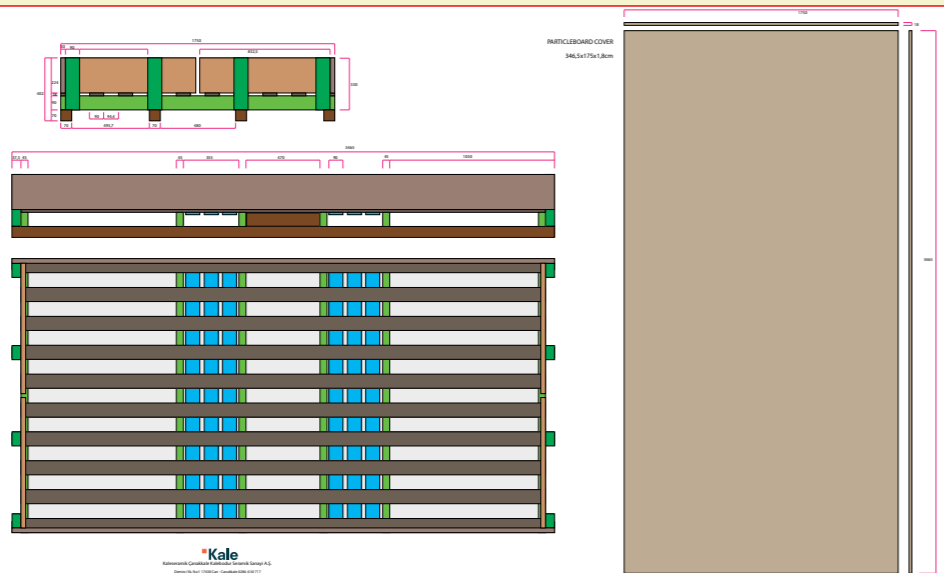

A-Frame / Pallet / Crate

110200100265
PINE CRATE 175X346X40 CM 296 DM³ IS

110200100264
PARTICLEBOARD CRATE COVER
175X346X1,8CM SLAB

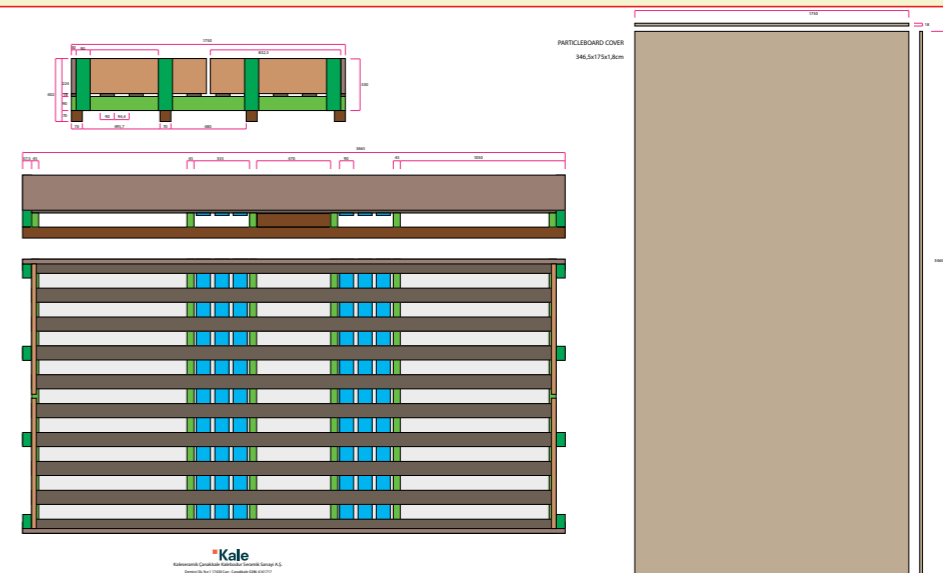

Product Index of Packaging Materials

110200100265	PINE CRATE 175X346X40 CM 296 DM ³ IS	1 piece
110200100264	PARTICLEBOARD CRATE COVER 175X346X1,8CM SLAB	1 piece
110200600050	STYROFOAM 60x100x2cm	18 pieces-to bottom and uppermost
110400100220	INSTRUCTION FOR SLAB-LOADING, UNLOADING AND CARRYING A&B	1 set (2 piece)
110200400134	LABEL 20X15CM 162X323 6-6,5MM 14A BX	2 piece
100200300086	STRETCH HOOD 2900-550-550 MM BX	1 piece

Unit Quantity Definitions

	Piece	Piece/Crate	40" Container
Piece	1	14	15
m2	5,23	73,22	1098,3
Weight (kg)	76,1	1265	18976
Size	162x323		
Thickness	6-6,5 mm		
Row/Layer		14	

Product Index of Packaging Materials

110200100265	PINE CRATE 175X346X40 CM 296 DM ³ IS	1 piece
110200100264	PARTICLEBOARD CRATE COVER 175X346X1,8CM SLAB	1 piece
110200600050	STYROFOAM 60x100x2cm	18 pieces-to bottom and uppermost
110400100220	INSTRUCTION FOR SLAB-LOADING, UNLOADING AND CARRYING A&B	1 set (2 piece)
110200400134	LABEL 20X15CM 160X320 12MM 6A BX	2 piece
100200300086	STRETCH HOOD 2900-550-550 MM BX	1 piece

Unit Quantity Definitions

	Piece	Piece/Crate	40" Container
Piece	1	6	15
m2	5,12	30,720	460,80
Weight (kg)	148,9	1093	16399,0
Size	160x320		
Thickness	12 mm		
Row/Layer		6	

Labels and Marking / Tying

Part Label / Marking



100x150mm parça etiketi

A-Frame/ Pallet / Crate Label



Pallet label 150x100mm

Instructions to be attached to the crate
110400100220 INSTRUCTION FOR SLAB-LOADING, UNLOADING AND CARRYING A&B

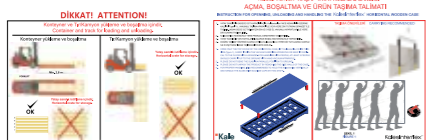

Tying



110200400134
LABEL 20X15CM 160X320 6-6,5MM 14A BX

Labels and Marking / Tying

Part Label / Marking



110200400139
LABEL 20X15CM
160X320 12MM 6A BX



Pallet label 150x100mm

A-Frame/ Pallet / Crate Label

Instructions to be attached to the crate
110400100220 INSTRUCTION FOR SLAB-LOADING, UNLOADING AND CARRYING A&B

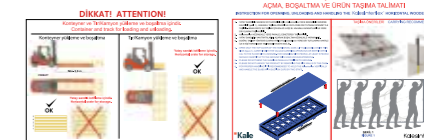

Tying

A-Frame / Pallet / Crate

110200100265
PINE CRATE 175X346X40 CM 296 DM³ IS

110200100264
PARTICLEBOARD CRATE COVER
175X346X1,8CM SLAB

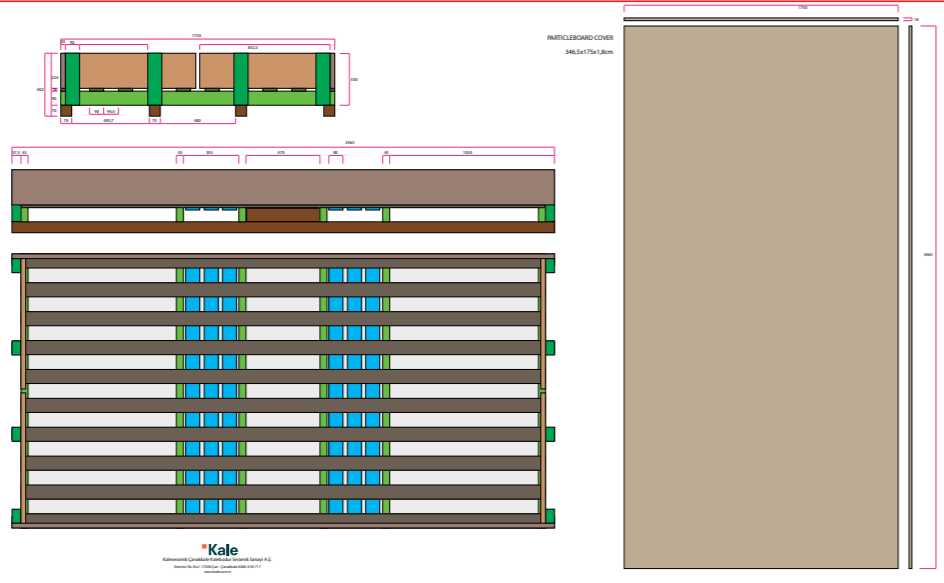

Product Index of Packaging Materials

110200100265	PINE CRATE 175X346X40 CM 296 DM ³ IS	1 piece
110200100264	PARTICLEBOARD CRATE COVER 175X346X1,8CM SLAB	1 piece
110200600050	STYROFOAM 60x100x2cm	18 pieces-to bottom and uppermost
110400100220	INSTRUCTION FOR SLAB-LOADING, UNLOADING AND CARRYING A&B	1 set (2 piece)
110200400134	LABEL 20X15CM 162X323 12MM 6A BX	2 piece
100200300086	STRETCH HOOD 2900-550-550 MM BX	1 piece

Unit Quantity Definitions

	Piece	Piece/Crate	40" Container
Piece	1	6	15
m2	5,23	31,38	470,7
Weight (kg)	152,2	1113,0	16694,0
Size	162x323		
Thickness	12 mm		
Row/Layer		6	

Labels and Marking / Tying

Part Label / Marking



100x150mm parça etiketi

A-Frame/ Pallet / Crate Label



Pallet label 150x100mm

Tying

Instructions to be attached to the crate
110400100220 INSTRUCTION FOR SLAB-LOADING,
UNLOADING AND CARRYING A&B



Certificates

Sertifikalar

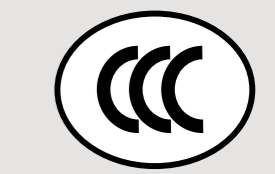
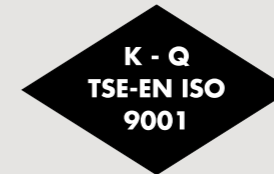

Kale

Kaleseramik Çanakkale Kalebodur Seramik San. A.Ş.
Büyükdere Cad. Kaleseramik Binası 34330 Levent - İstanbul / Türkiye
T: 0850 800 5253

kale.com.tr



4110400200177